

General

The key to any window or door installation is preparation. This extends from storage of the product to the final installation and to all points in between. Careful planning and attention to detail can help ensure proper installation.

Operational Warning

1. Fleetwood products operate smoothly and special care should be taken by the owner to make sure users are not injured.
2. Live or dead loads transferred into our product can affect functionality, damage frame joinery or cause glass failures. Dead loads such as upper levels, roof, etc. should be constructed before Door or Window is installed.
3. Loads shall be designed to withstand the most critical effects of load factors and load combinations as required by the building code. (Loads are including but not limited to Live, Dead, Collateral, Auxiliary, Thermally induced, Seismic, etc.)
4. Maximum vertical deflection of the header under all Load combination should not exceed the $\text{Span}/720$ or $1/4$ " whichever is less.

Note: For installations beyond these limitations, a structural engineer should be consulted for specific requirements.

Storage

Windows are finished products and must be protected against damage. When storing windows, handle the materials carefully. To avoid racking or damage to the products or their accessories, do not drop or drag them from the delivery truck. Stack the windows with the direction arrows in the proper direction and allow adequate non-abrasive separators so the products do not rub together. Be sure to store the windows off the ground (e.g., on pallets or planks, etc.). Protect the stored products against the elements by using a well ventilated covering, preferably inside in a dry environment. If the packaging becomes wet, unpack the windows and repack with dry materials, then move to a dry location. Wet cardboard can cause swift and severe damage to anodized and painted finishes.

Sealant Requirements

- The sealant referred to within this document for seals associated with the assembly of the product should conform to **AAMA 800**. It is recommended that all other sealants should also conform to **AAMA 800** but may be a sealant recommended and approved by the sealant manufacturer that is compatible with the framing, finish and surrounding materials.
- All sealant bead sizes must conform to the sealant manufacturers' size requirements.
- The Owner / General Contractor is responsible for identifying the need for any additional sealant to be applied by others. Such sealant shall be elastomeric material, with the framing, finish and surrounding materials.

Sillpan Substitution

If the factory provided sillpan is not desired, the product warranty will remain intact if the substitute panning system emulates the essential design of the factory pan.

Extreme Weather Conditions (Thermally Broken Product Only)

1. For installations that will be exposed to extreme weather, apply a compatible sealant on top of the thermal break cavity of all sills, t-bars and stack bars as shown.
2. Fleetwood provides an aluminum sill pan for each of its insulated (thermal break) products. If concerns exist for either frost transfer or condensation through the sill pan, we recommend taking steps to "de-bridge" the pan or use other flashing. In the case of the latter, the installer takes full responsibility to make sure the flashing is a design replicating the factory provided pan.

APPLY SEALANT
FULL LENGTH.

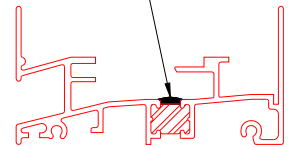

Assembly and Installation

It is essential that each Fleetwood product be assembled and glazed in accordance with AAMA standards and factory instructions. It is the installer's responsibility to ensure that each Fleetwood product is assembled, glazed and installed and completely sealed to ensure that the product is leak-free and operates correctly. **Installation of Fleetwood products must be in accordance with the standards set forth in ASTM E 2112.** If there are any questions regarding the installation of a Fleetwood product contact the factory customer service department.

"When hinged screens are available please note: To maintain minimalism, surface applied handles are not provided by Fleetwood"

Nail-fin Window Frames

The following procedure applies to all Nail-fin installations, regardless of the window series, configuration or operation of the product being installed (i.e., Horizontal Sliding Window, Casement, Fixed Picture Window, Single Hung, etc.).

Note: The flashing referred to in this document is Moistop paper flashing but may refer to other code compliant flashing material that conforms to Federal Specification UU-B-790a, Type 1, Grade A, Style 4. When using Moistop paper, the strips of paper are to be no less than 9 inches wide (or wider as required by local codes). Flashing paper must be applied with galvanized nails or corrosion resistant staples. Flashing paper shall be applied in a weatherboard fashion around the full perimeter of the framed opening.

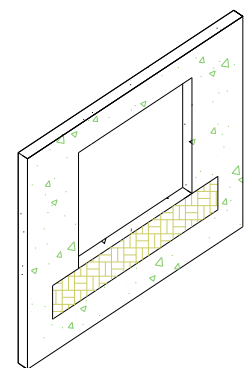

Figure 1

1. Check the measurements of the opening and make sure that the window frame you have will fit the opening.
2. Apply the first strip of flashing paper horizontally immediately below the sill, cut sufficiently long enough to extend past each side of the window, so that it projects at least 3 inches past the vertical flashing to be applied later (Figure 1).

3. Fasten the top edge of the sill flashing paper to the framing, but do not fasten the lower edge, so the weather resistant building paper, applied later, may be slipped up and underneath the window flashing paper in a weatherboard fashion.
4. Non-porous, non-absorbent, inorganic shims are then required to be applied to the framed opening sill to support the window and maintain it in a straight and level condition and to prevent rotation. Apply sealant to the back side of the L-shaped aluminum corner pieces (if required) and attach to the exterior face of the nail-fin at the corners as shown in figure 2a. Apply a continuous ½" bead of sealant to the backside (interior) of the nail-on flange at the head and jambs only. Do not apply sealant on the backside of the nail-on flange at the sill. **IMPORTANT:** Apply a heavy bead of sealant to the interior side of the mounting flange (nail-fin) where the window frame jamb and sill join. Sealant must cover the entire joint (from the flange to the inside leg of the window) and extend 1½" up the jamb and along the sill. (See Fig. 2b).
5. When product is thermally broken or I-mulled to another product, apply sealant in all corners or seams of the sillpan to make the pan watertight (See Fig. 3A). Insert sillpan into the opening and set on leveled shims and in a full bed of sealant. Apply (2) continuous beads of sealant to the inside corner (frame side) of the sillpan (See Fig. 3B). These beads of sealant will seal against the interior corner of the installed window frame.

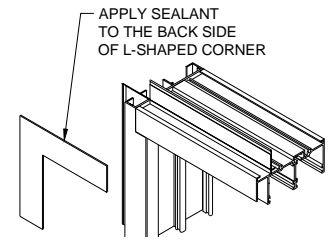

Figure 2a

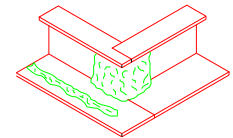

Figure 2b

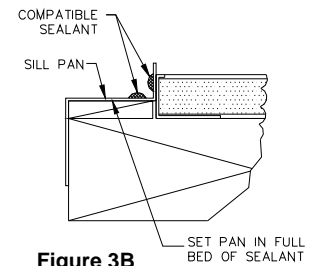
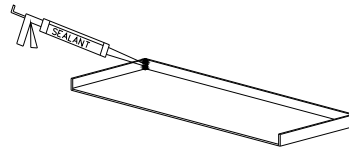

Figure 3B

Figure 3A



6. Insert the window into the opening (See Fig. 4). Shim with non-porous, non-absorbent, inorganic shims at head and jambs, cross measure and adjust as necessary to achieve a plumb, square and level condition, as well as an even reveal around the frame opening. Ensure that there are no crowns and dips in the head, jambs or sill. Secure the full perimeter of the window with the equivalent of 6d galvanized or corrosion resistant fasteners at 12 inches (maximum) on center. Hinged and pivoted windows require additional fasteners located within 1 inch each side of, and in the same plane as the hinge or pivot. Seal all fastener heads during installation with sealant. In each direction from the corners there must be a fastener within 6 inches, but no closer than 3 inches, to prevent frame distortion or fracture of joint seals.
7. Due to transportation, unloading and handling during installation there is the potential for factory applied joint seals to be compromised. The installer is responsible for the integrity of all framing joints after installation and must therefore water test all joints to guarantee a completely sealed product. Apply joint sealer and / or sealant necessary to ensure watertight joints. Retest as necessary.
8. Once satisfied that the window is watertight, and immediately prior to application of the flashing paper at head and jambs, apply a continuous bead of sealant to the exposed mounting flange (nail-fin) at the top (head) and sides (jambs) of the installed window. Also, apply sealant at corners of the window, the full length of the seam where mounting flanges (nail-fin) meet.

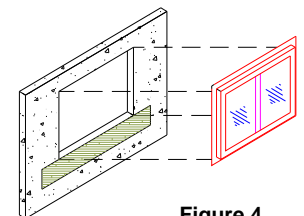

Figure 4

Window Frame Installation Instructions

For Nail-on and Block Frames

9. At each jamb, embed the flashing paper into the sealant on the mounting flange and fasten in place. The flashing paper should be cut sufficiently long enough to extend at least 3 inches past the sill flashing paper and at least 6 inches above the head of the window. (See Fig. 5)
10. Finally, at the window head, embed the flashing into the sealant on the mounting flange and fasten into place. The flashing paper should be cut sufficiently long enough to extend past the flashing paper at each jamb by at least 3 inches. (See Fig. 6).
11. Weather resistant building paper should be applied in a weatherboard fashion to complete the installation. (See Fig. 7).
12. Where weather resistant building paper, insulating board, or other materials by other trades may constitute the primary weather barrier, behind the exterior wall finish (i.e., stucco, masonry, siding, etc.), the Owner / General Contractor is responsible to ensure that the weather barrier is continuous by effectively sealing the material to the window frame.
13. To complete the installation, apply backer rod (size dependant on shim space and determined by installer) and sealant to the entire interior joint between the frame and the building structure.

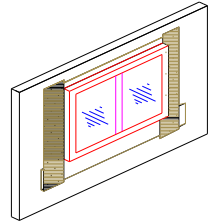

Figure 5

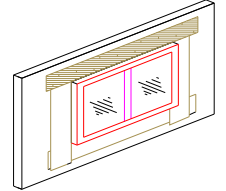

Figure 6

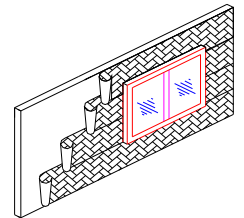

Figure 7

Block Window Frames

The following procedure applies to all Block Frame (Equal Leg) Horizontal Sliding Window, Casement, Fixed Picture Window, Single Hung, etc.

1. Check the measurements of the opening and make sure that the window frame you have will fit the opening.
2. Non-porous, non-absorbent, inorganic shims are required to be applied to the framed opening or masonry sill to support the window and maintain it in a straight and level condition and to prevent rotation.
3. Drill holes for frame anchors in the frame prior to installation of the frame.
4. When product is thermally broken or I-mulled to another product and requires a sillpan, apply sealant in all corners or seams of sill- pan to make pan watertight (See Fig. 8A). Insert sillpan into the opening and set on leveled shims and in a full bed of sealant. Apply (2) continuous beads of sealant to the inside corner (frame side) of the sillpan (See Fig. 8B). These beads of sealant will seal against the interior corner of the installed window frame. Do not apply sealant to the exterior edge of the sillpan.

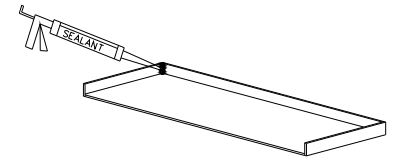

Figure 8A

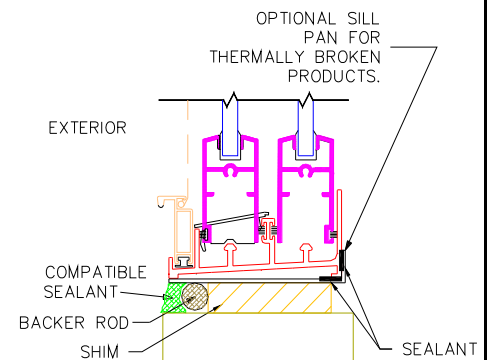

Figure 8B

5. Insert the window into the opening and onto the sillpan. Stuff closed cell backer rod (size dependant on shim space and determined by installer) in cavity and seal remaining cavity (See Fig 8B). Shim as necessary, cross measure and adjust as necessary to achieve a plumb, square and level condition. Ensure that there are no crowns and dips in the head, jambs or sill. Secure the full perimeter of the window with corrosion resistant # 8 x 2" Pan Head Sheet Metal Screws with masonry anchors, if required, at 12 inches (maximum) on center. Note: Single and Double Hung Window Jambs are to be anchored with countersunk # 8 x 2" Flat Head Sheet Metal Screws with lead masonry anchors, if required, at 12 inches (maximum) on center. Fasteners should be staggered alternately from towards the exterior side of the frame to towards the interior side of the frame to ensure uniformity. Hinged and pivoted windows require additional fasteners located within 1 inch each side of the hinge or pivot. Seal all fastener heads during installation with compatible sealant.
6. Great care should be taken when anchoring the sill, in order that the unsealed penetration is not created in a hidden cavity.
7. In each direction from the corners there must be a fastener within 6 inches, but no closer than 3 inches, to prevent frame distortion or fracture of joint seals.
8. Due to transportation, unloading and handling during installation there is the potential for factory applied joint seals to be compromised. The installer is responsible for the integrity of all framing joints after installation. Apply joint sealer and / or sealant necessary to ensure watertight joints.

- To complete the installation, apply backer rod (size dependant on shim space and determined by installer) and a complete bead of sealant to the entire exterior and interior joint between the frame and the building structure. Tool the sealant to eliminate bubbles, voids and / or breaks and ensure a completely watertight seal.

Post Installation

Glass Film:

Film applied to the outdoor surface of the glass should be removed within 9 months of window installation for best results. The film should be removed at a glass temperature between 32° and 140°F. Typically, as the film is exposed to UV, humidity and heat, the adhesion of the film to glass will increase. In addition, as the temperature at removal decreases, the adhesion of the film to the glass will typically increase. Under normal circumstances, removing the film within 9 months will help ensure easy removal with little to none of the film's adhesive remaining on the glass. Removal is typically easiest when starting from the edge of one of the overlapping layers. If the increase in adhesion is large enough to make the starting of film removal difficult, a plastic scraper or plastic putty knife may be used to start film removal. Razor blades should never be used on the glass surface due to the high potential for scratching or scoring the glass.

Glass & Frame Protection:

Fleetwood strongly recommends protecting the entire door or window product after installation. Consult the manufacturer of such protective materials to ensure comparability with glass, glass film, components & metal finish.

Security Alarms:

Third party security systems that utilize sensors and magnets can be applied to Fleetwood products as long as operation and weather performance are not compromised. Contact our Customer Service Department to review areas of concern.

Automation:

Third party automation can be applied to Fleetwood products as long as operation and weather performance are not compromised.

Galvanic Corrosion

Whenever dissimilar metals are placed in contact with each other, or in close proximity, there is a potential hazard for corrosion. In the presence of an electrolyte such as moisture (especially salt water) the two metals are "bridged", forming an electrical couple. Once the couple is created there is an exchange of electrons. In layman's terms, one metal extracts mass from the other, thus causing corrosion. If you have ever seen a white chalky substance on the thresholds you have seen galvanic corrosion. How can galvanic corrosion be prevented?

- Isolate:** Make sure the installer totally isolates dissimilar metals by placing inert materials between them. This prevents the moisture from "bridging" the two materials thus failing the creation of an electrical couple.
- Clean:** Follow the Care & Maintenance Instructions and dry out these areas as quickly as possible to stop any electrical couples from developing.
- Sacrificial Anode:** In some situations, the builder and or architect require the joining of dissimilar metals. If steps 1 and 2 above are not successful we recommend the use of a material that is weaker than the other metals. This will act as the anode, which will be robbed of its electrons instead of the favored metals. Contact your builder/architect for more data on how to make this happen.