

Option A

Without Fin(s) (std)

Option B

With Fin(s)

Option C

With Blade(s) at Corner

90° Corner

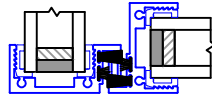

Exterior

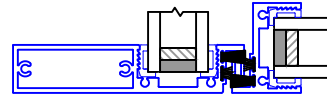

Exterior

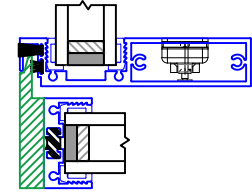

Exterior

110° Corner

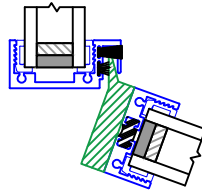

Exterior

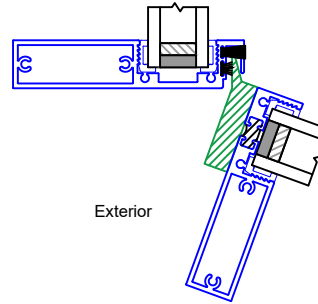

Exterior

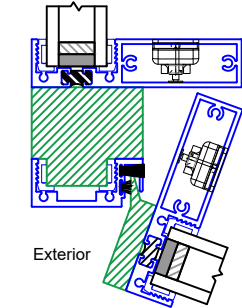

Exterior

135° Corner

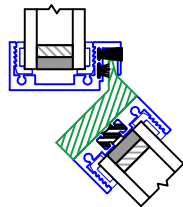

Exterior

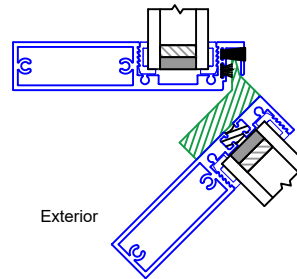

Exterior

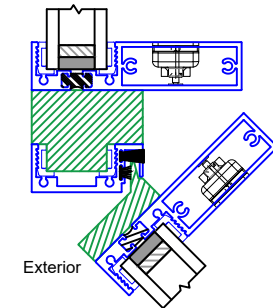

Exterior

Note:

Additional custom angles available (25°-180°)