

# ASSEMBLY / PARTS LIST (B.O.M.)

**Series: EDGE |f|**  
**Type: OVO-GTF with Arche-Duct, 1 1/2" Glass Shown**

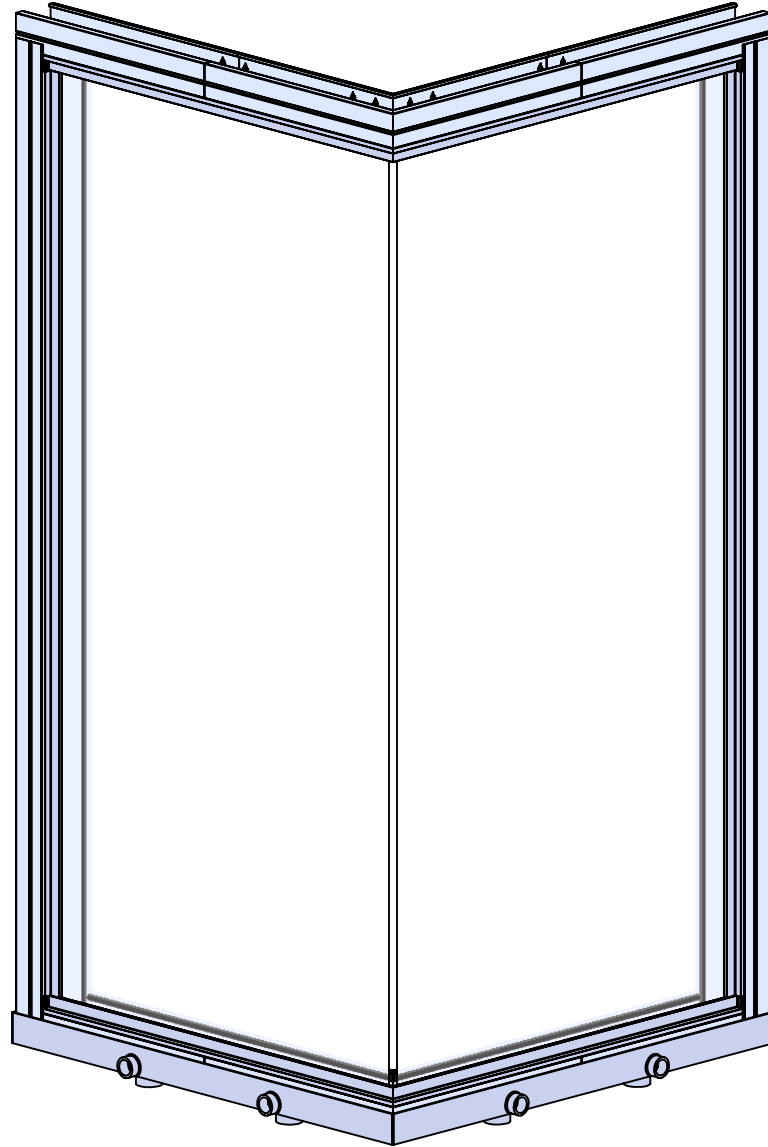

ITEM NO.	DESCRIPTION	PAGE #
1	EDGE  f  ASSEMBLY	2
2	TABLES	3

**PROPRIETARY AND CONFIDENTIAL**  
 THE INFORMATION CONTAINED IN THIS DRAWING IS THE SOLE PROPERTY OF FLEETWOOD WINDOWS & DOORS.  
 ANY REPRODUCTION IN PART OR AS A WHOLE WITHOUT THE WRITTEN PERMISSION OF FLEETWOOD WINDOWS & DOORS IS PROHIBITED.

Description Table of Contents	
File Name EDGE f Assembly OVO-GTF	REV <b>A</b>
Released 3/24/2023	SHEET 1 OF 3

# ASSEMBLY / PARTS LIST (B.O.M.)

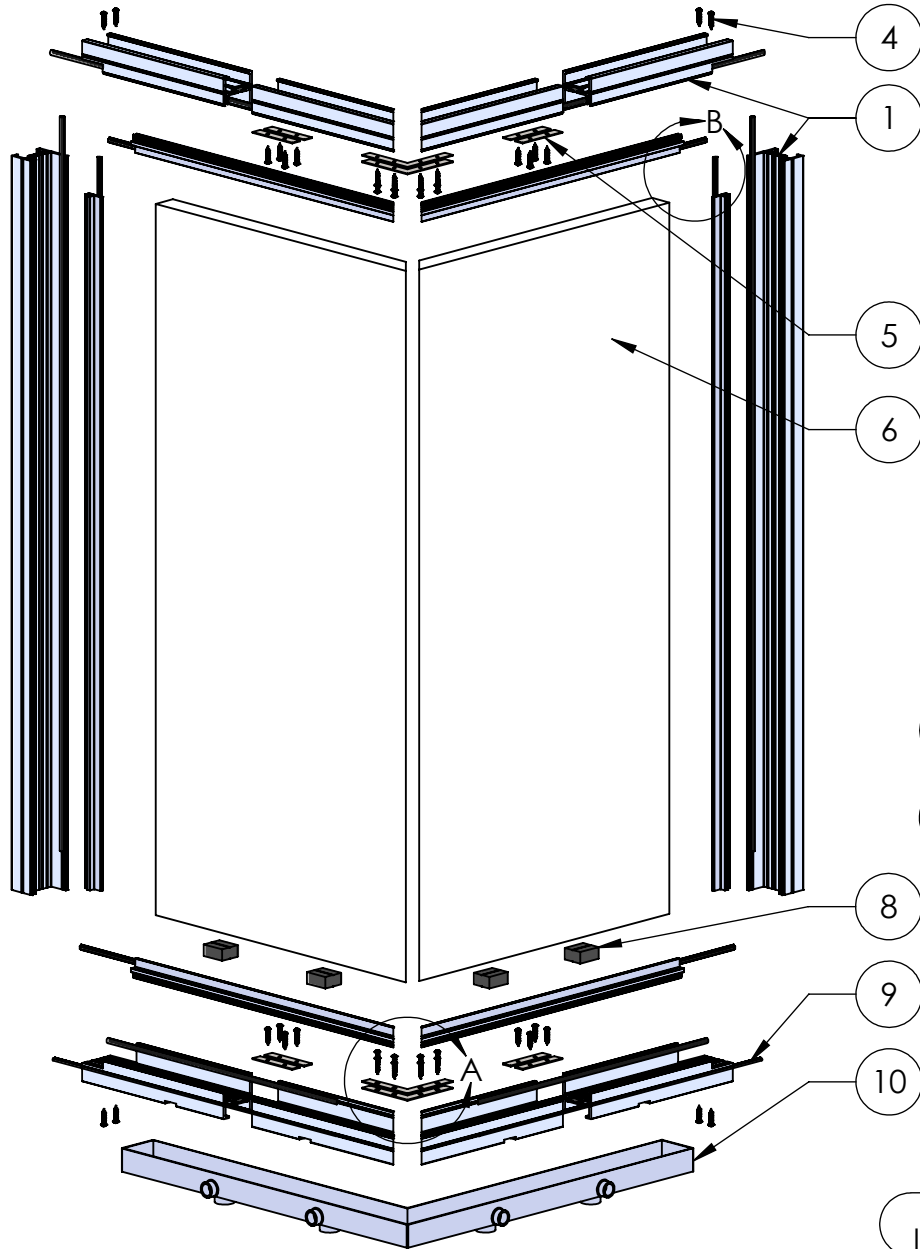

EXTRUSIONS			
ITEM NO.	PART NUMBER	DESCRIPTION	QTY.
1	Ef0009	Head/Sill	10
2	See Table A	Glass Wedge	6
HARDWARE			
3	25031	Bulb Vinyl-Large	12
4	20350	#10 Screw, PHP-A, 1", SS, Clear	40
5	27135	Head-Sill Splice Plate	8
6	-	Glass (1 1/2" Shown)	2
7	25037	Corner Door Sill Brace	4
8	See Table B	Setting Block	4
9	25189	Q-Lon Foam Seal (Q225T190)	4
10	FW1217	Arche-duct Narrow Pan	1

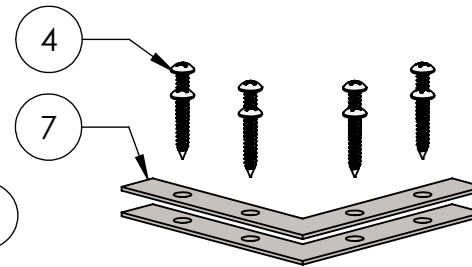

DETAIL A

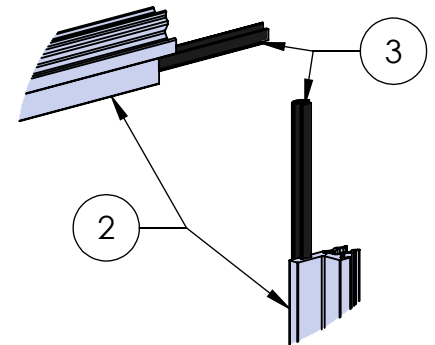

DETAIL B

Splice Head/Sill when length is greater than 180"

**PROPRIETARY AND CONFIDENTIAL**  
 THE INFORMATION CONTAINED IN THIS DRAWING IS THE SOLE PROPERTY OF FLEETWOOD WINDOWS & DOORS.  
 ANY REPRODUCTION IN PART OR AS A WHOLE WITHOUT THE WRITTEN PERMISSION OF FLEETWOOD WINDOWS & DOORS IS PROHIBITED.

Description EDGE   f   Assembly	
File Name EDGE f Assembly OVO-GTF	REV <b>A</b>
Released 3/24/2023	SHEET 2 OF 3

# ASSEMBLY / PARTS LIST (B.O.M.)

**Table A - Glass Wedges**

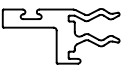
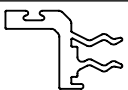
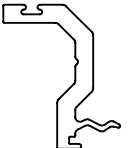
Ef0004	Jamb Interior and Low Profile Head/Sill	
Ef0005	1.5" Glass (Shown)	
Ef0006	1.25 " Glass	
Ef0007	9/16" Glass	

**Table B- Setting Blocks**

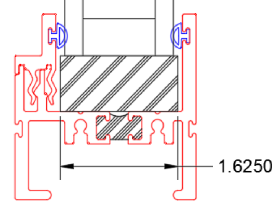
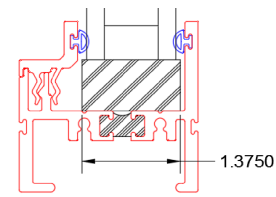
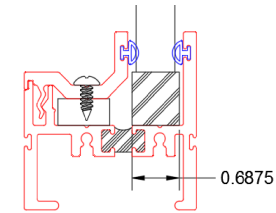
Glass (in)	Setting Block	Orientation	QTY
1.5 (Shown)	26829, 1 3/8"x1 5/8"x3/4" Setting Block		4
1.25	26829, 1 3/8"x1 5/8"x3/4" Setting Block		4
9/16	26829, 1 3/8"x1 5/8"x3/4" Setting Block- <b>1 3/8" width cut in half</b>		4

Description

Tables

File Name

EDGE f Assembly OVO-GTF

REV  
**A**

Released

3/24/2023

SHEET 3 OF 3

**PROPRIETARY AND CONFIDENTIAL**

THE INFORMATION CONTAINED IN THIS DRAWING IS THE SOLE PROPERTY OF FLEETWOOD WINDOWS & DOORS.  
ANY REPRODUCTION IN PART OR AS A WHOLE WITHOUT THE WRITTEN PERMISSION OF FLEETWOOD WINDOWS & DOORS IS PROHIBITED.