

ASSEMBLY / PARTS LIST (B.O.M.)

Series: EDGE |f|
Type: O-GTF with Arche-duct, 1 1/2" Glass Shown

ITEM NO.	DESCRIPTION	PAGE #
1	EDGE f ASSEMBLY	2
2	TABLES	3

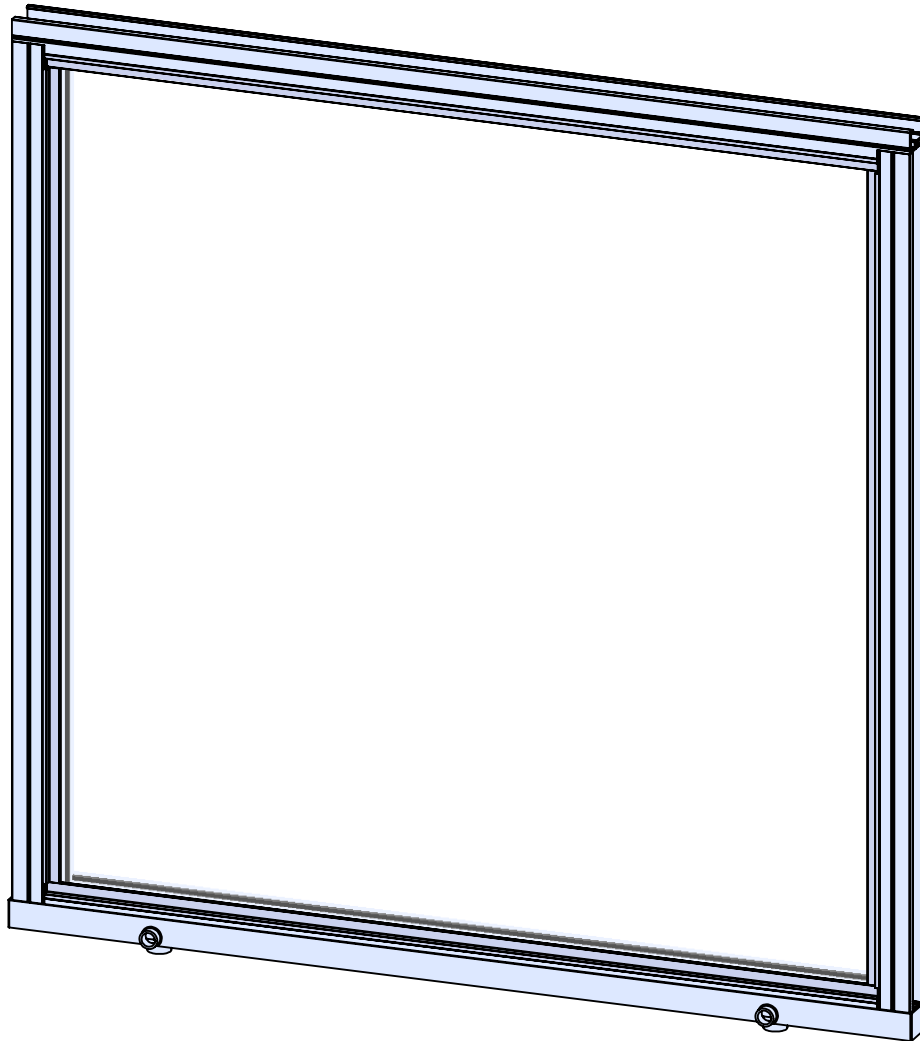

Description Table of Contents	
File Name EDGE f Assembly O-GTF	REV A
Released 3/24/2023	SHEET 1 OF 3

PROPRIETARY AND CONFIDENTIAL
 THE INFORMATION CONTAINED IN THIS DRAWING IS THE SOLE PROPERTY OF FLEETWOOD WINDOWS & DOORS.
 ANY REPRODUCTION IN PART OR AS A WHOLE WITHOUT THE WRITTEN PERMISSION OF FLEETWOOD WINDOWS & DOORS IS PROHIBITED.

ASSEMBLY / PARTS LIST (B.O.M.)

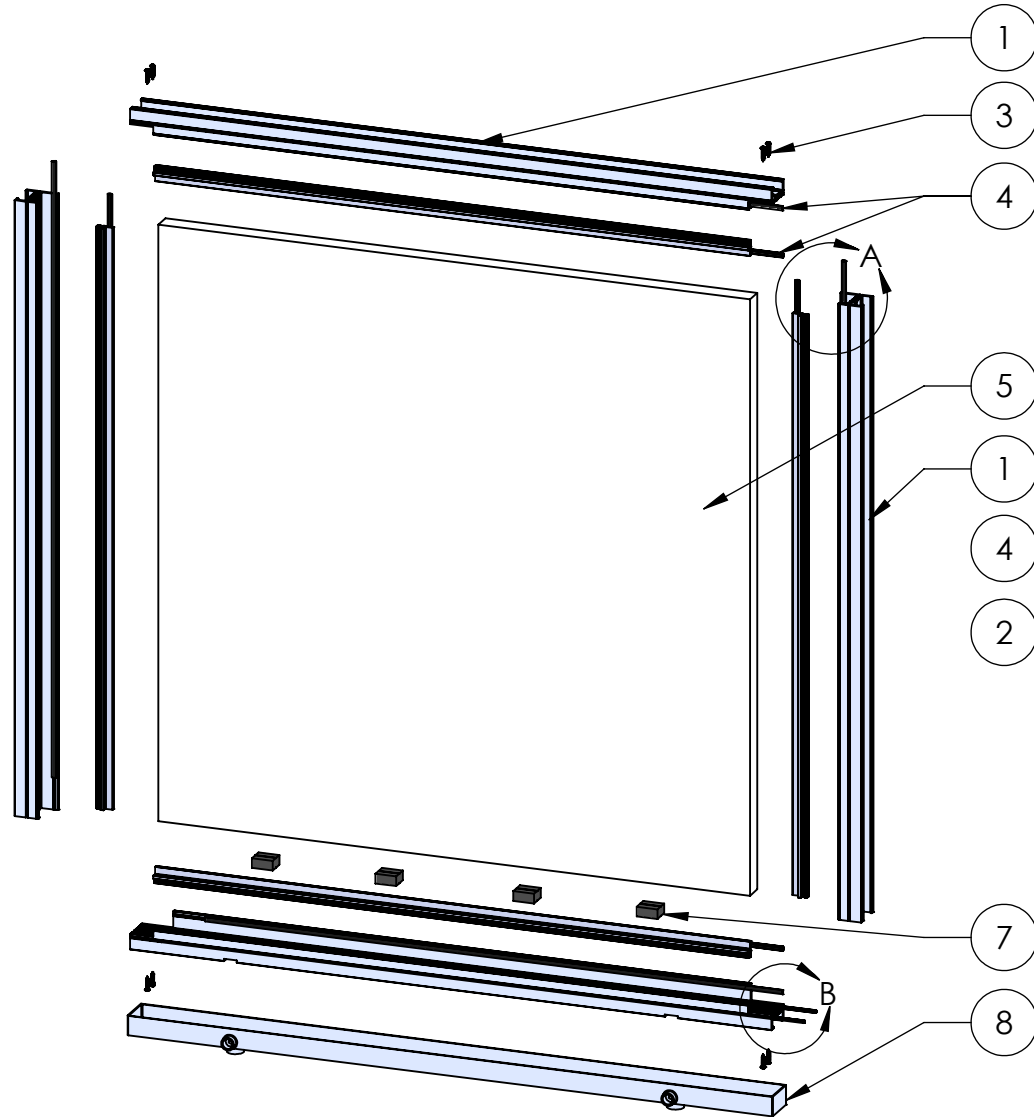

EXTRUSIONS			
ITEM NO.	PART NUMBER	DESCRIPTION	QTY.
1	Ef0009	Head/Sill/Jamb	4
2	See Table A	Glass Wedge	4
HARDWARE			
3	20350	#10 Screw, PHP-A, 1", SS, Clear	8
4	25031	Bulb Vinyl-Large	8
5	-	Glass (1 1/2" Shown)	1
6	25189	Q-Lon Foam Seal (Q225T190)	2
7	See Table B	Setting Block	-
8	FW1217	Arche-duct Narrow Pan	1

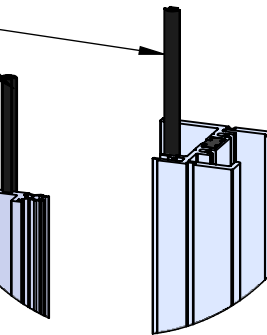

DETAIL A

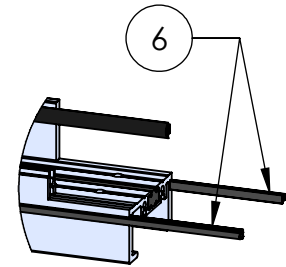

DETAIL B

Description EDGE f Assembly	
File Name EDGE f Assembly O-GTF	REV A
Released 3/24/2023	SHEET 2 OF 3

ASSEMBLY / PARTS LIST (B.O.M.)

Table A - Glass Wedges

Ef0004	Jamb Interior and Low Profile Head/Sill	
Ef0005	1.5" Glass (Shown)	
Ef0006	1.25 " Glass	
Ef0007	9/16" Glass	

Table B- Setting Blocks

Glass (in)	Setting Block	Orientation	QTY
1.5 (Shown)	26829, 1 3/8"x1 5/8"x3/4" Setting Block		4
1.25	26829, 1 3/8"x1 5/8"x3/4" Setting Block		4
9/16	26829, 1 3/8"x1 5/8"x3/4" Setting Block- 1 3/8" width cut in half		4

Description

Tables

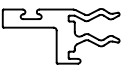
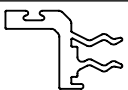
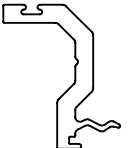
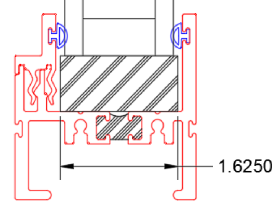
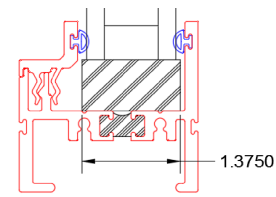
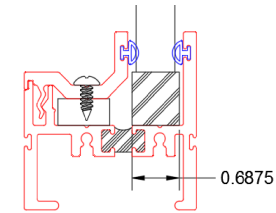
File Name

EDGE f Assembly O-GTF

REV
A

Released

3/24/2023

SHEET 3 OF 3

PROPRIETARY AND CONFIDENTIAL

THE INFORMATION CONTAINED IN THIS DRAWING IS THE SOLE PROPERTY OF FLEETWOOD WINDOWS & DOORS. ANY REPRODUCTION IN PART OR AS A WHOLE WITHOUT THE WRITTEN PERMISSION OF FLEETWOOD WINDOWS & DOORS IS PROHIBITED.