

(USE RULER TO SCALE DIMENSIONS IN INCHES)
SCALE: 1/4

INTERLOCKER OPTIONS

①
HP INTERLOCKERS
(STD)

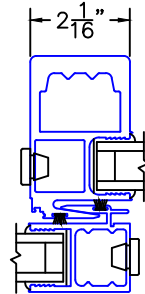

EXTERIOR

②
HP INTERLOCKERS
(BOTH)

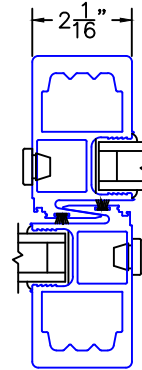

EXTERIOR

③
2-PIECE POCKET
INTERLOCKER WITH
REVERSE HP INTERLOCKER

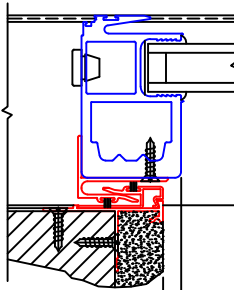

EXTERIOR

④
L-TYPE POCKET
INTERLOCKER WITH
REVERSE HP INTERLOCKER

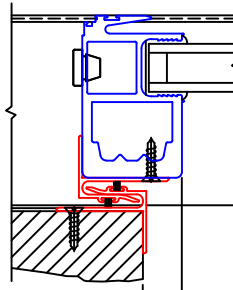

EXTERIOR

⑤
J-POST POCKET
INTERLOCKER WITH
REVERSE HP INTERLOCKER

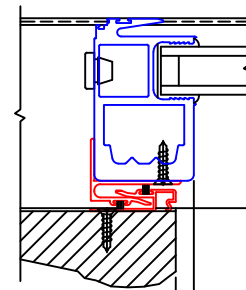

EXTERIOR

⑥
NARROW INTERLOCKERS

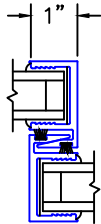

EXTERIOR

⑦
NARROW HP INTERLOCKERS
(INTERIOR SHOWN)

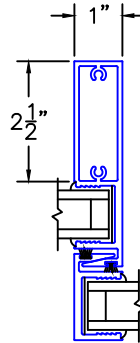

EXTERIOR

⑧
NARROW HP INTERLOCKERS
(BOTH SIDES)

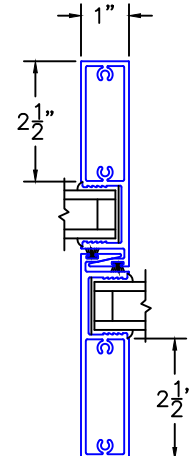

EXTERIOR

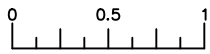

(USE RULER TO SCALE DIMENSIONS IN INCHES)

SCALE: FULL

INTERLOCKER OPTIONS

1

HP INTERLOCKERS
(ONE SIDE-STD)

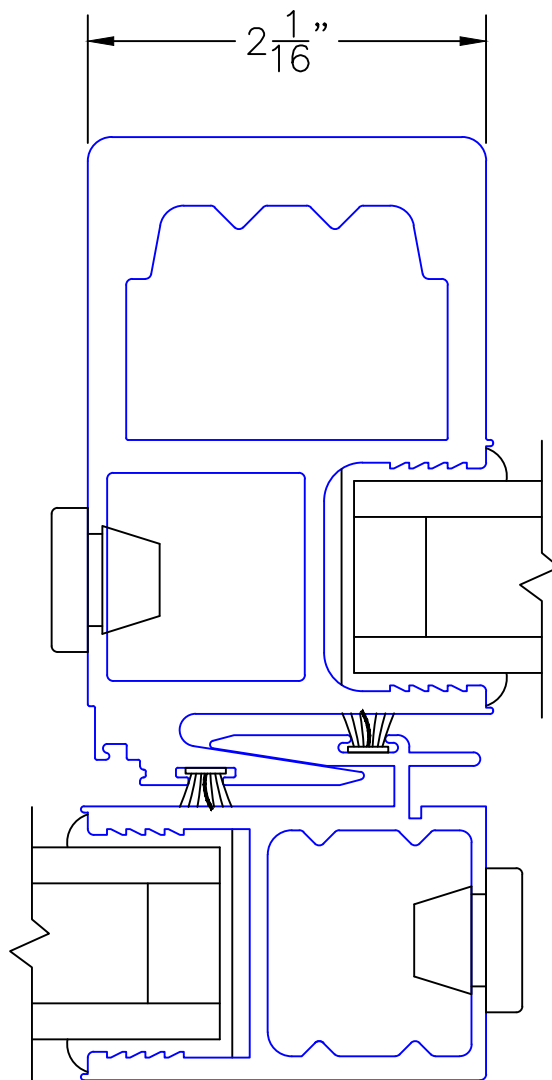

EXTERIOR

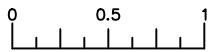

(USE RULER TO SCALE DIMENSIONS IN INCHES)

SCALE: FULL

INTERLOCKER OPTIONS

2

HP INTERLOCKERS
(BOTH SIDES)

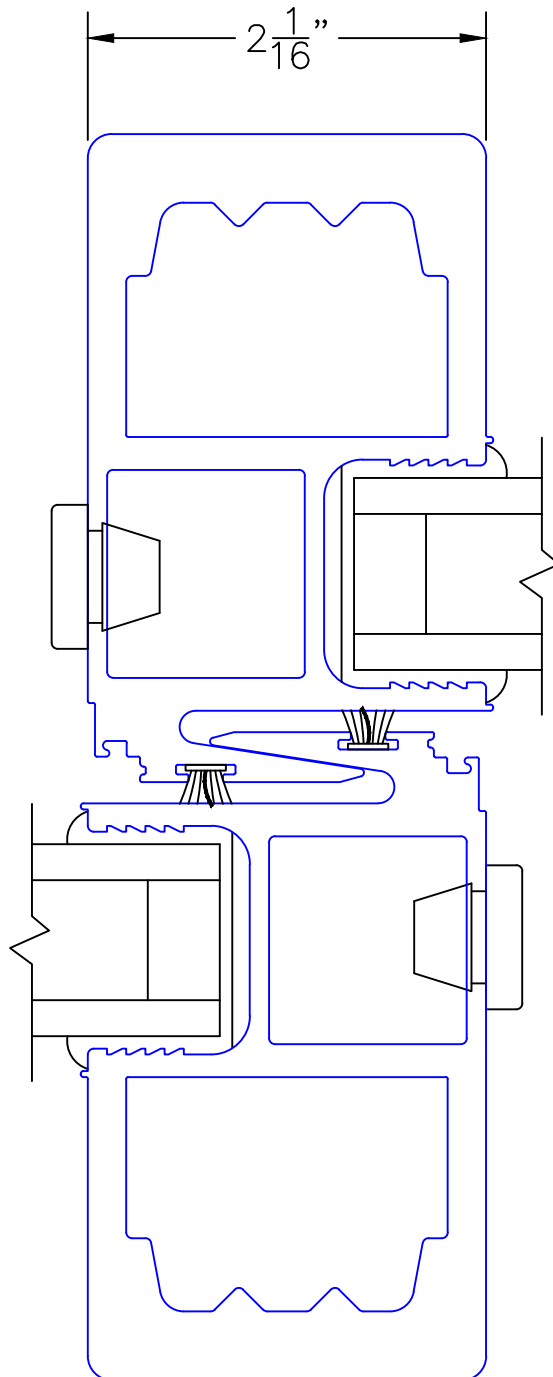

EXTERIOR

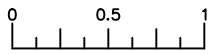

(USE RULER TO SCALE DIMENSIONS IN INCHES)

SCALE: FULL

INTERLOCKER OPTIONS

3

2-PIECE POCKET
INTERLOCKER WITH
REVERSE HP INTERLOCKER

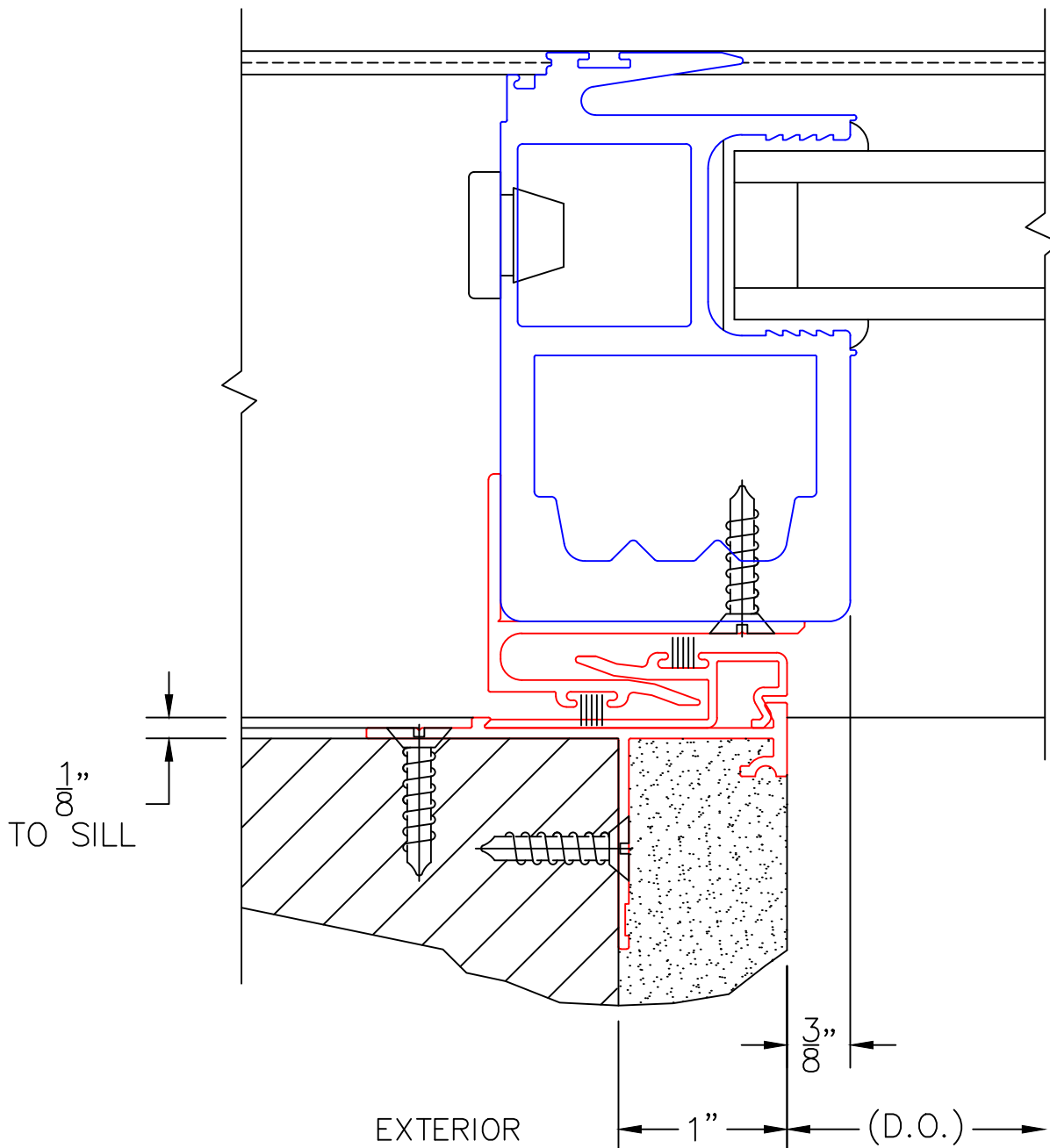

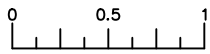

(USE RULER TO SCALE DIMENSIONS IN INCHES)

SCALE: FULL

INTERLOCKER OPTIONS

4

L-TYPE POCKET
INTERLOCKER WITH
REVERSE HP INTERLOCKER

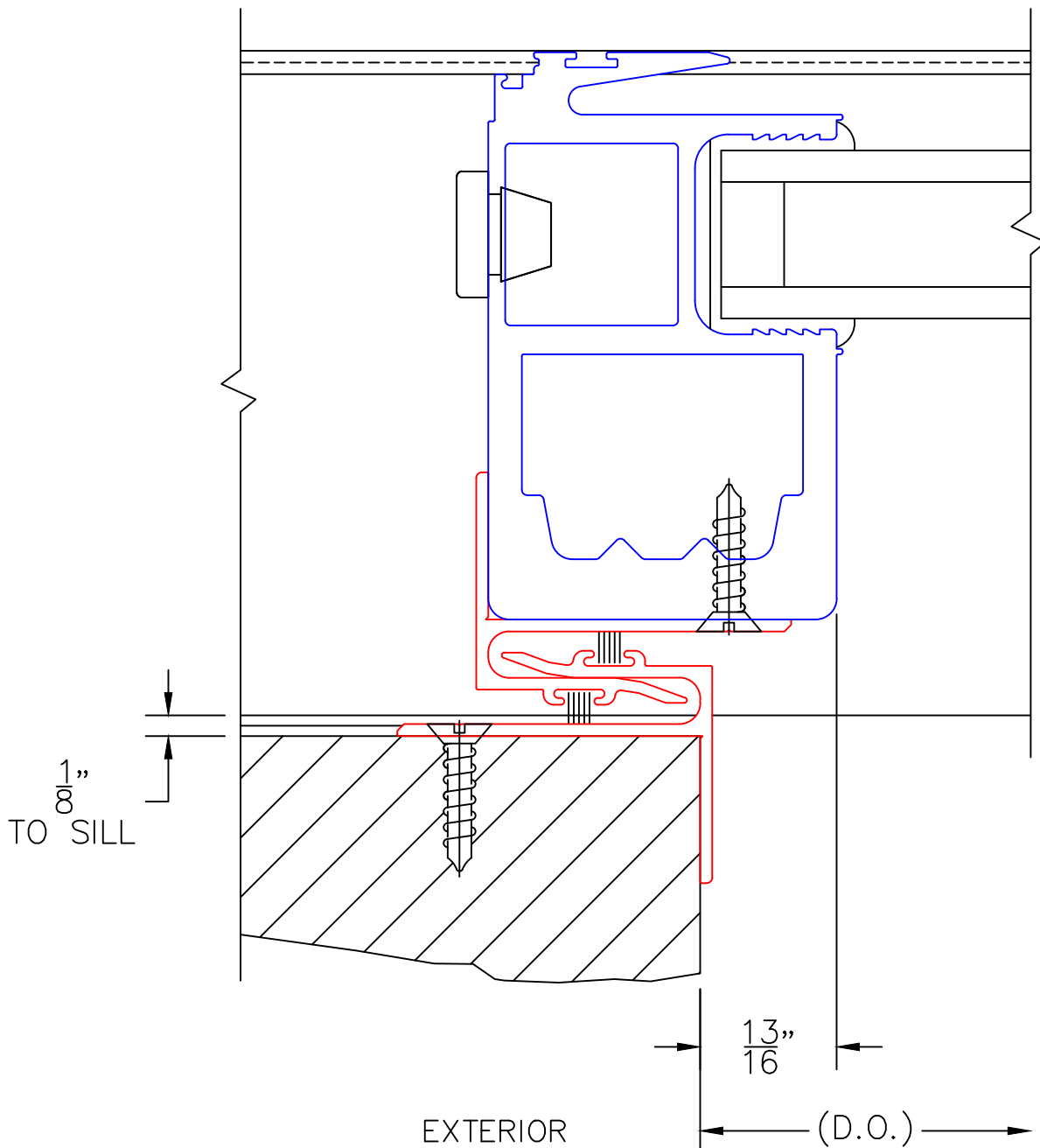

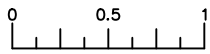

(USE RULER TO SCALE DIMENSIONS IN INCHES)

SCALE: FULL

INTERLOCKER OPTIONS

5

J-POST POCKET
INTERLOCKER WITH
REVERSE HP INTERLOCKER

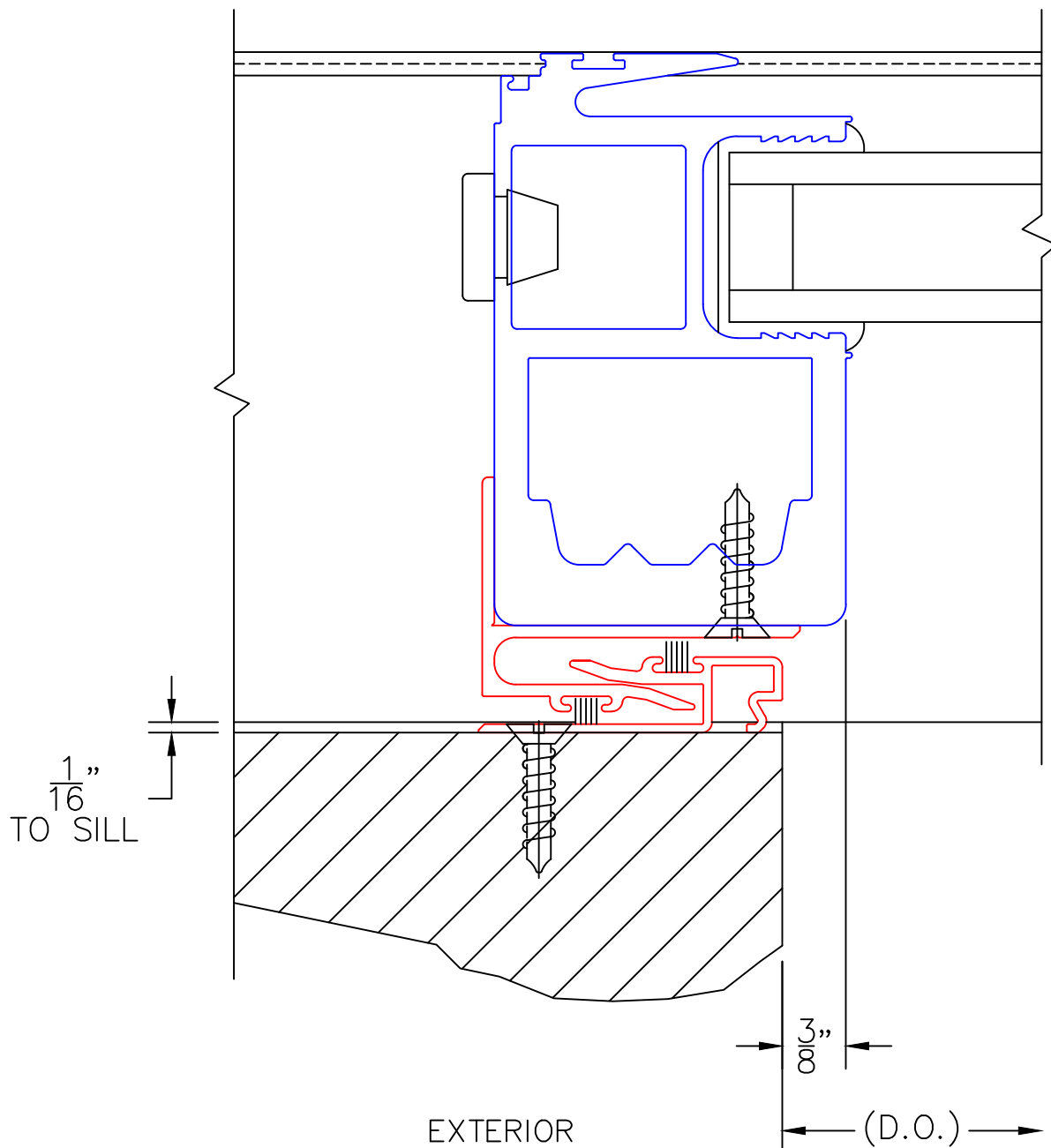

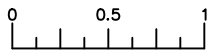

(USE RULER TO SCALE DIMENSIONS IN INCHES)

SCALE: FULL

INTERLOCKER OPTIONS

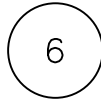

NARROW INTERLOCKERS

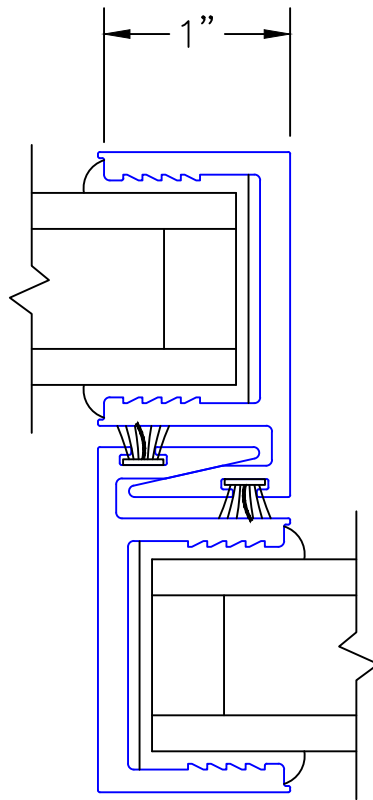

EXTERIOR

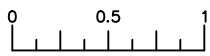

(USE RULER TO SCALE DIMENSIONS IN INCHES)

SCALE: FULL

INTERLOCKER OPTIONS



NARROW HP INTERLOCKERS
(INTERIOR SHOWN)

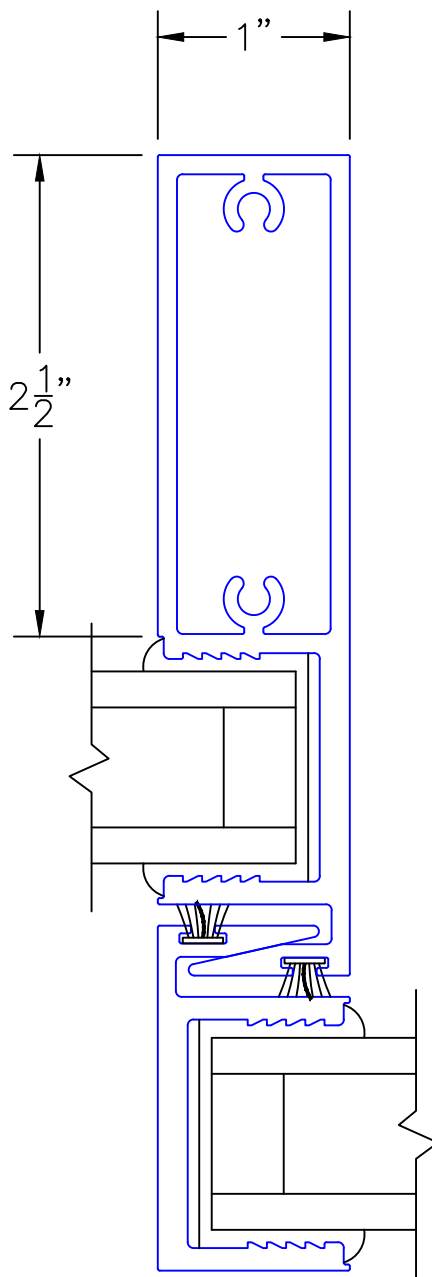

EXTERIOR

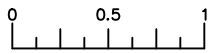

(USE RULER TO SCALE DIMENSIONS IN INCHES)

SCALE: FULL

INTERLOCKER OPTIONS

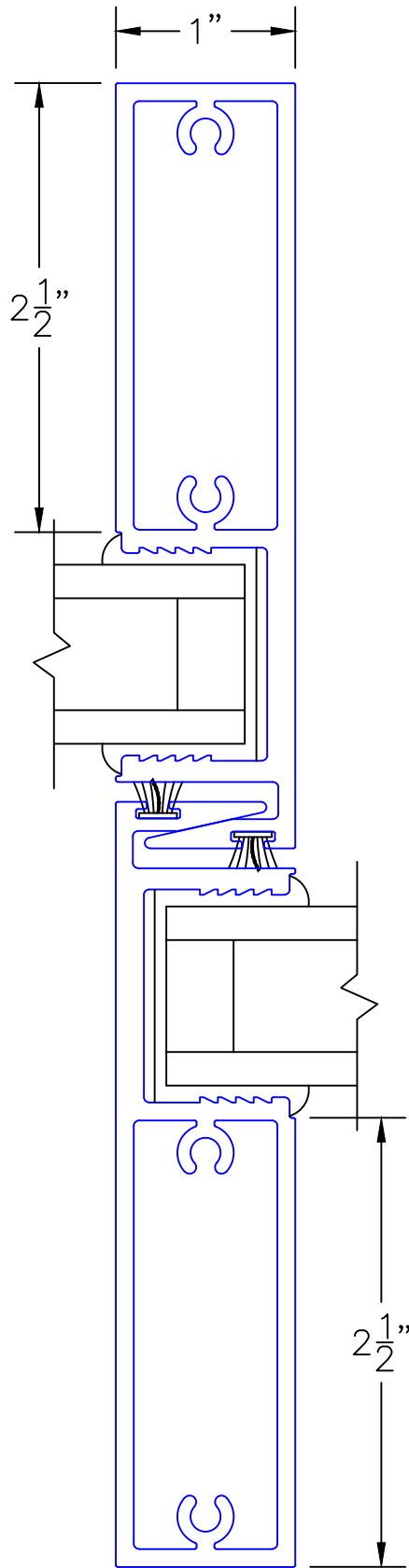

8

NARROW HP INTERLOCKERS
(BOTH SIDES)

EXTERIOR