

(USE RULER TO SCALE DIMENSIONS IN INCHES)  
**SCALE: 1/4"**

GLAZED TO FRAME WINDOW DETAILS  
1/4" SINGLE AND 1" INSULATED  
GLAZING SHOWN

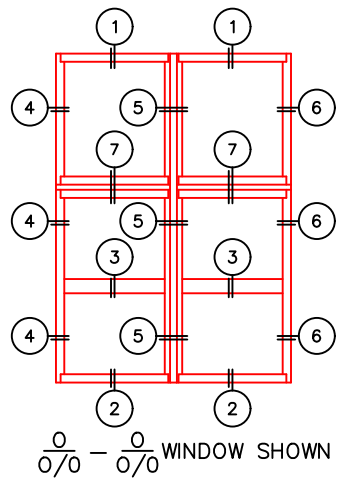
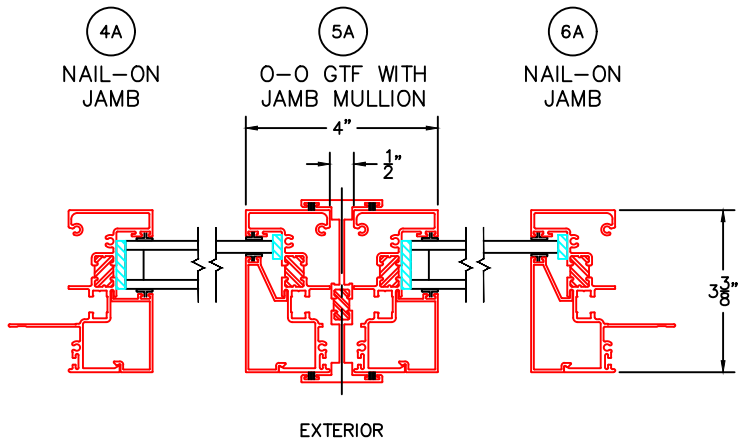
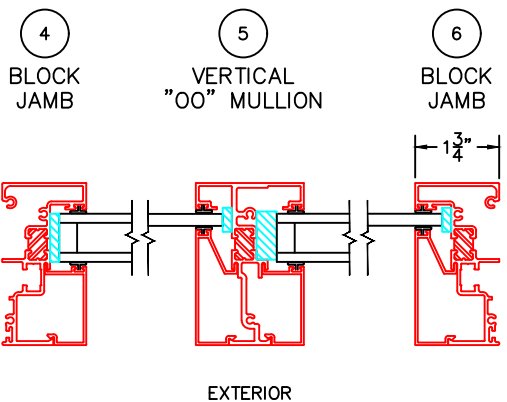
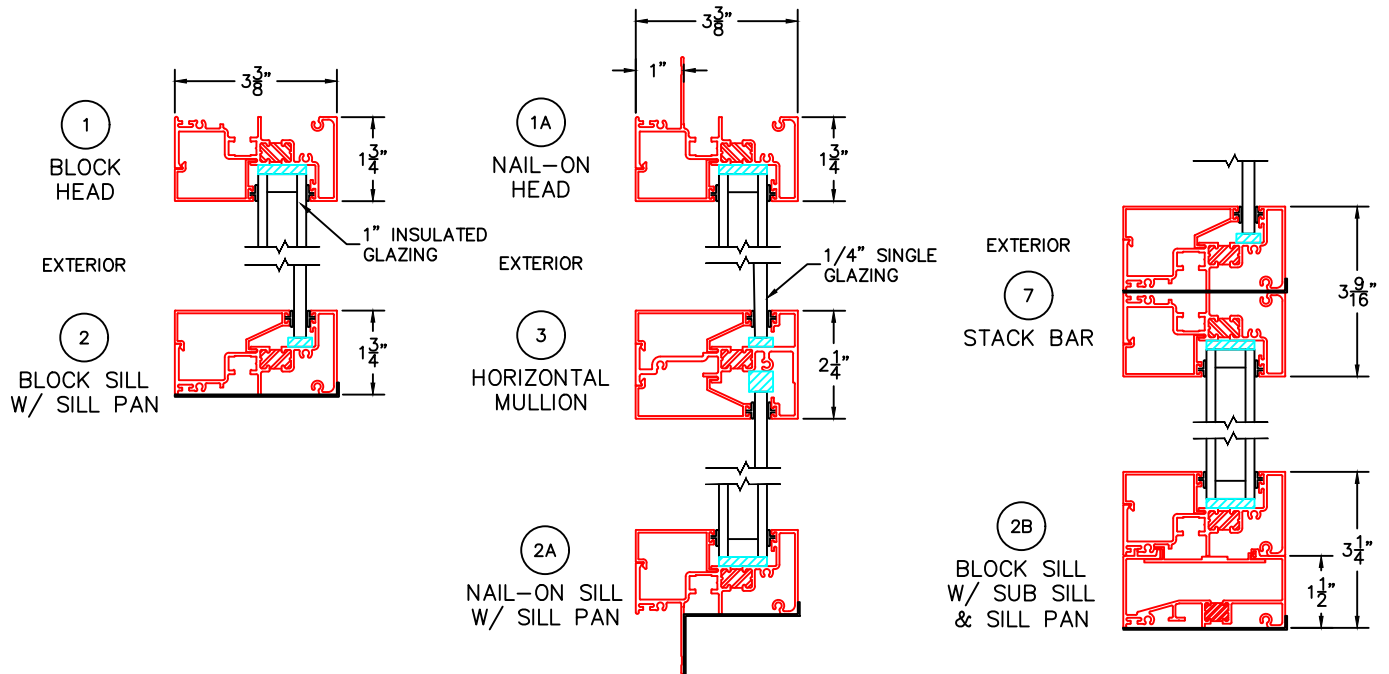

GLASS PENETRATION: 9/16"

0 0.5 1  
(USE RULER TO SCALE DIMENSIONS IN INCHES)  
**SCALE: FULL**

GLAZED TO FRAME WINDOW DETAILS  
1/4" SINGLE AND 1" INSULATED  
GLAZING SHOWN

1  
BLOCK HEAD

EXTERIOR

2  
BLOCK SILL  
W/ SILL PAN

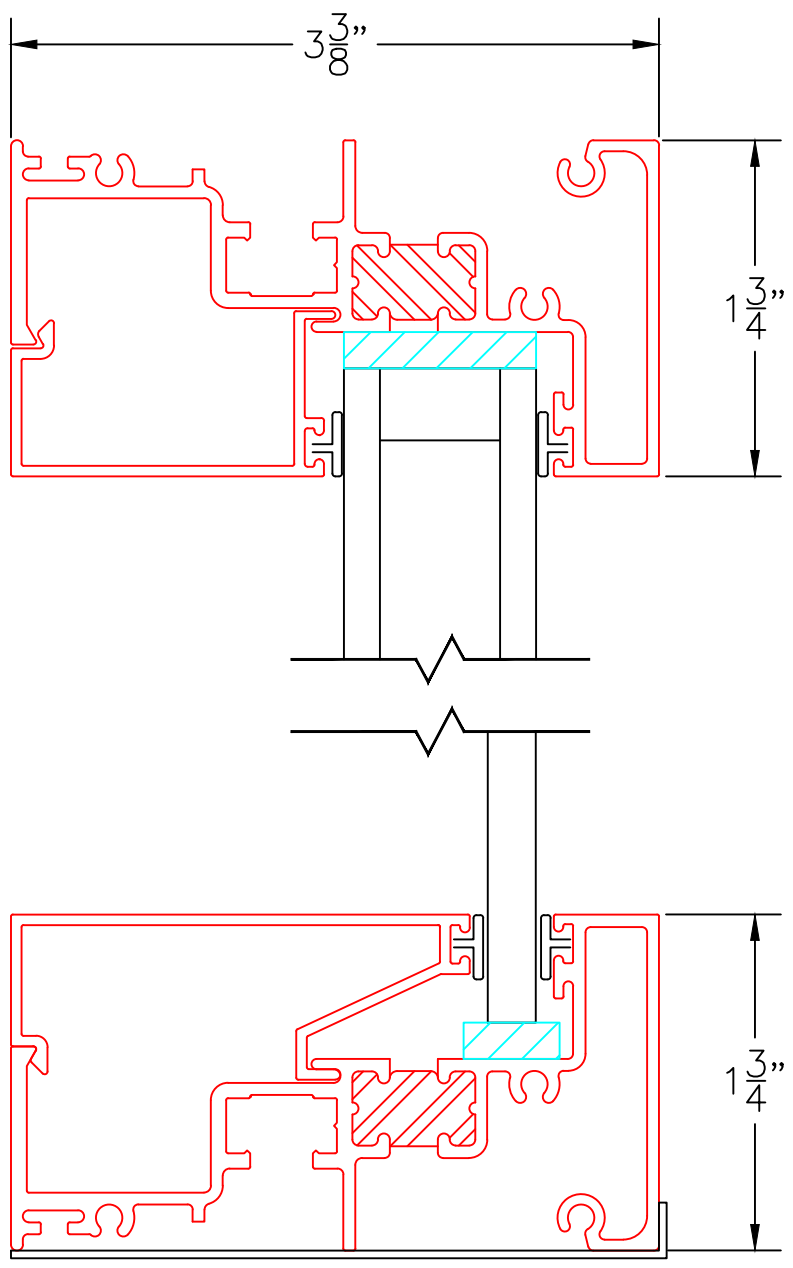

0 0.5 1  
(USE RULER TO SCALE DIMENSIONS IN INCHES)  
**SCALE: FULL**

GLAZED TO FRAME WINDOW DETAILS  
1" INSULATED GLAZING SHOWN

1A  
NAIL-ON  
HEAD

EXTERIOR

2A  
NAIL-ON SILL  
W/ SILL PAN

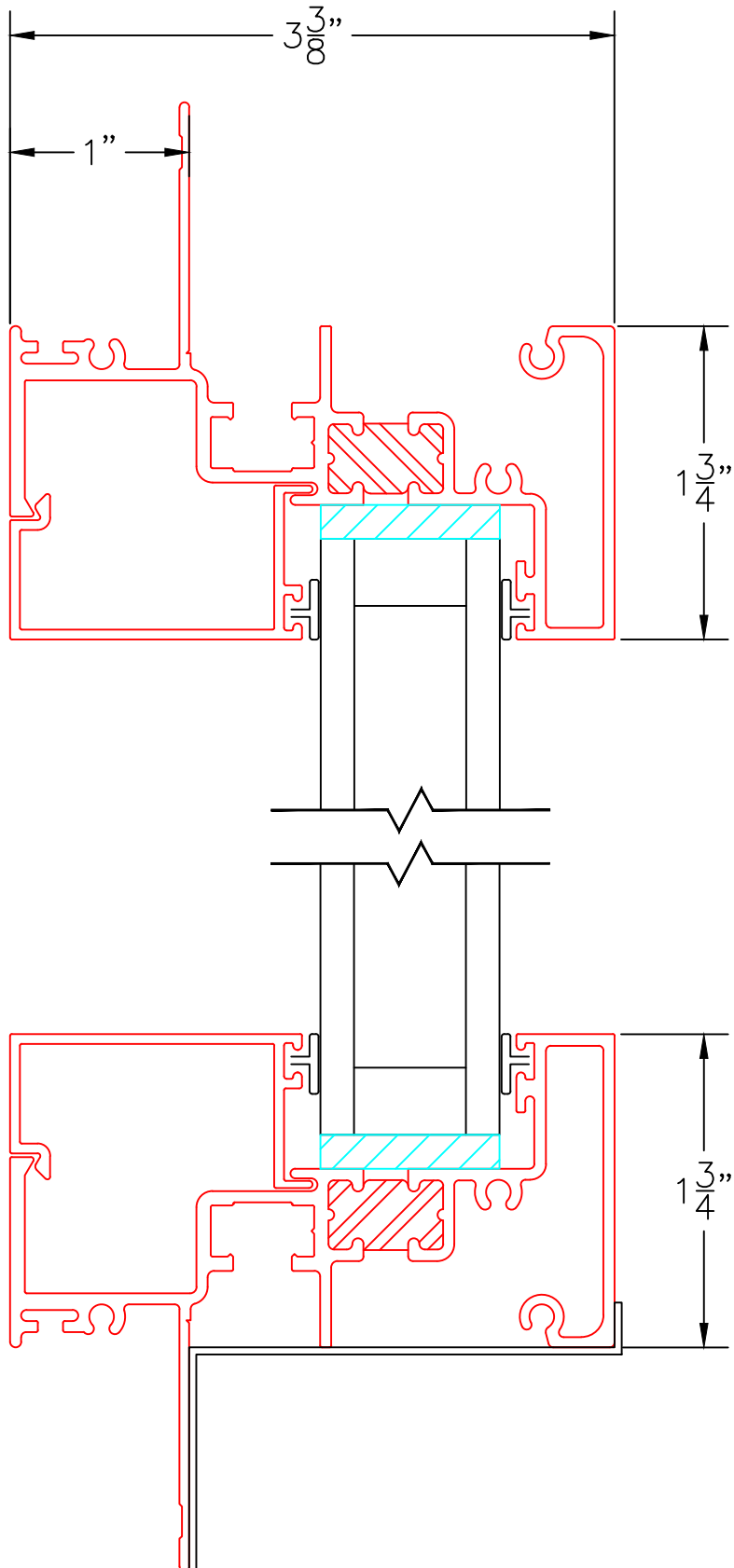

0 0.5 1  
(USE RULER TO SCALE DIMENSIONS IN INCHES)  
**SCALE: FULL**

GLAZED TO FRAME WINDOW DETAILS  
1" INSULATED GLAZING SHOWN

EXTERIOR

2B

BLOCK SILL  
W/ SUB-SILL  
AND SILL PAN

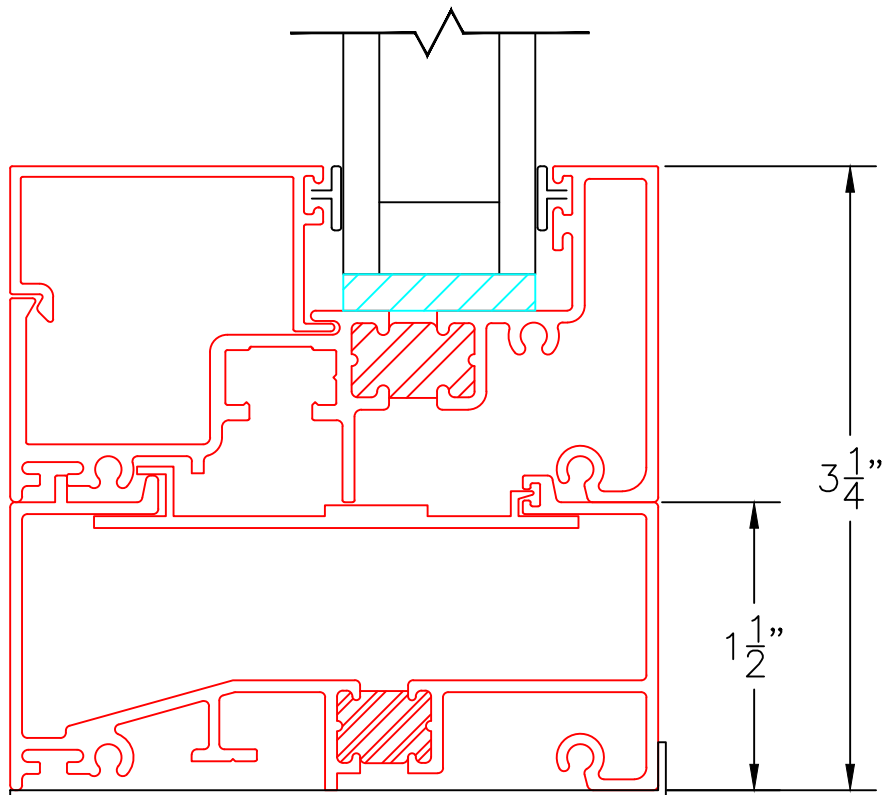

0 0.5 1  
(USE RULER TO SCALE DIMENSIONS IN INCHES)  
**SCALE: FULL**

GLAZED TO FRAME WINDOW DETAILS  
1/4" SINGLE GLAZING SHOWN

EXTERIOR

3  
HORIZONTAL  
MULLION

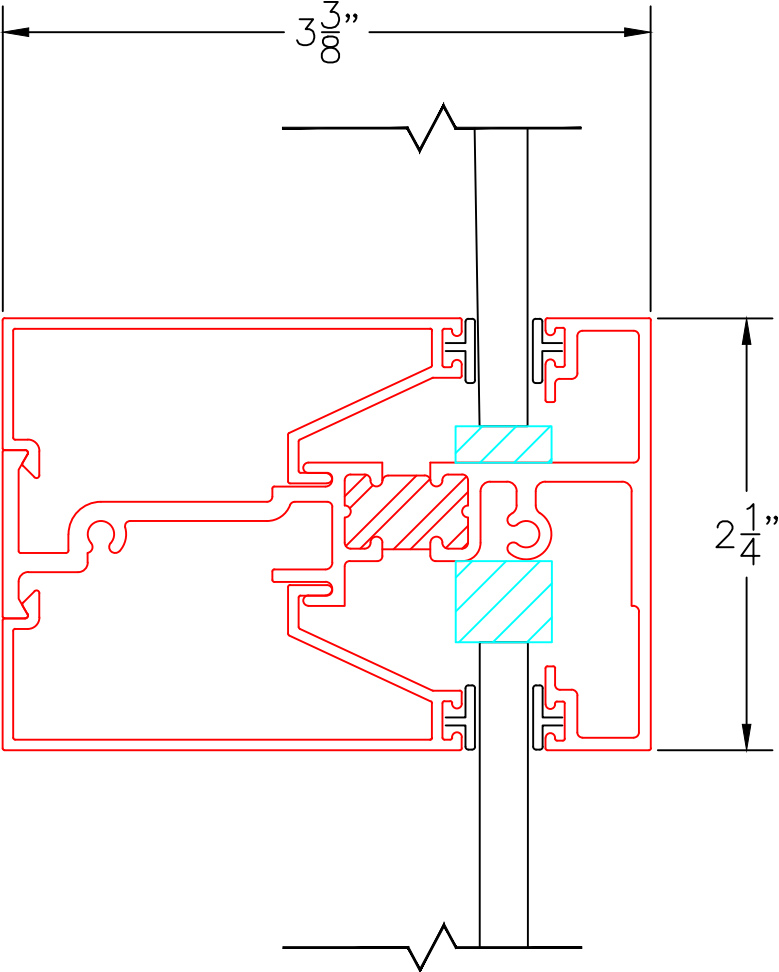

0 0.5 1  
(USE RULER TO SCALE DIMENSIONS IN INCHES)  
**SCALE: FULL**

## GLAZED TO FRAME WINDOW DETAILS 1/4" SINGLE AND 1" INSULATED GLAZING SHOWN

4

BLOCK  
JAMB

5

VERTICAL  
"OO" MULLION

6

BLOCK  
JAMB

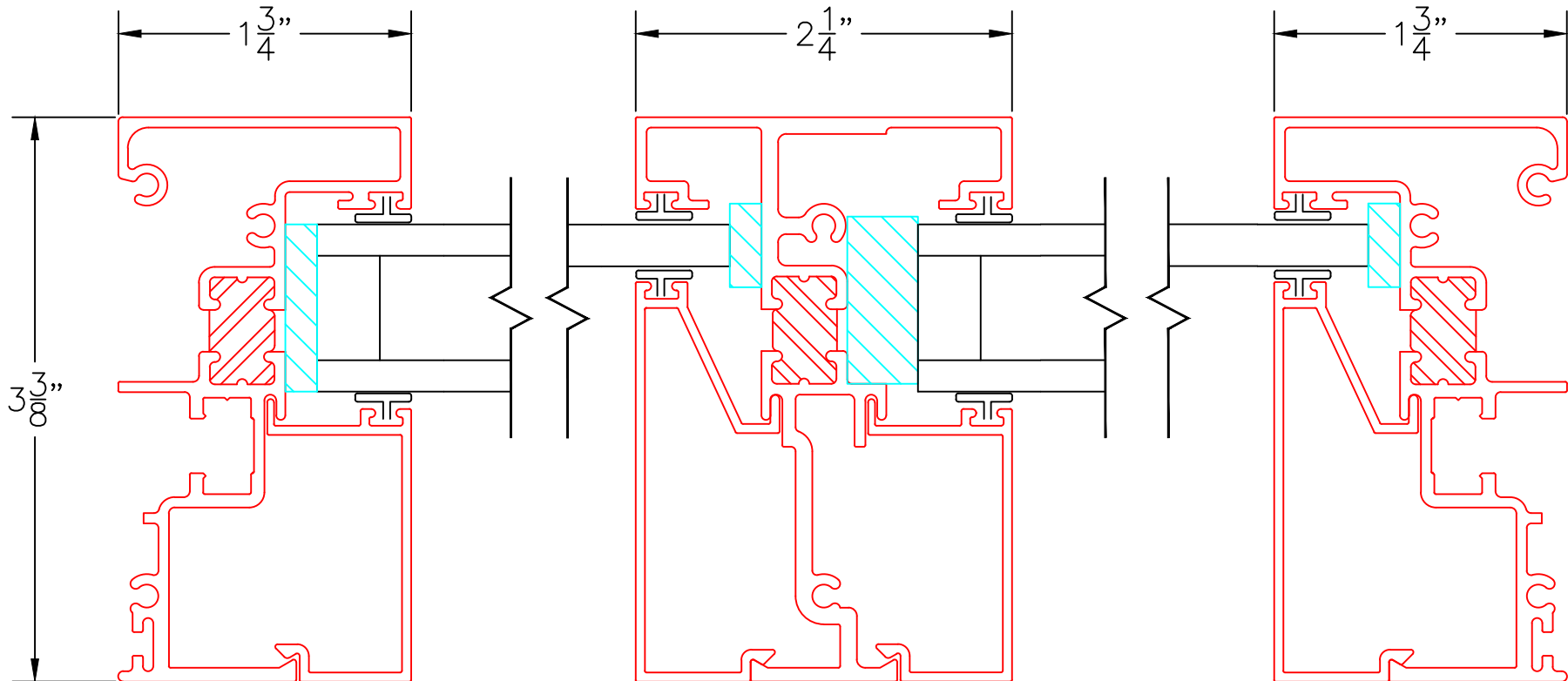

0 0.5 1  
(USE RULER TO SCALE DIMENSIONS IN INCHES)  
**SCALE: FULL**

## GLAZED TO FRAME WINDOW DETAILS 1/4" SINGLE AND 1" INSULATED GLAZING SHOWN

4A

NAIL-ON  
JAMB

6A

NAIL-ON  
JAMB

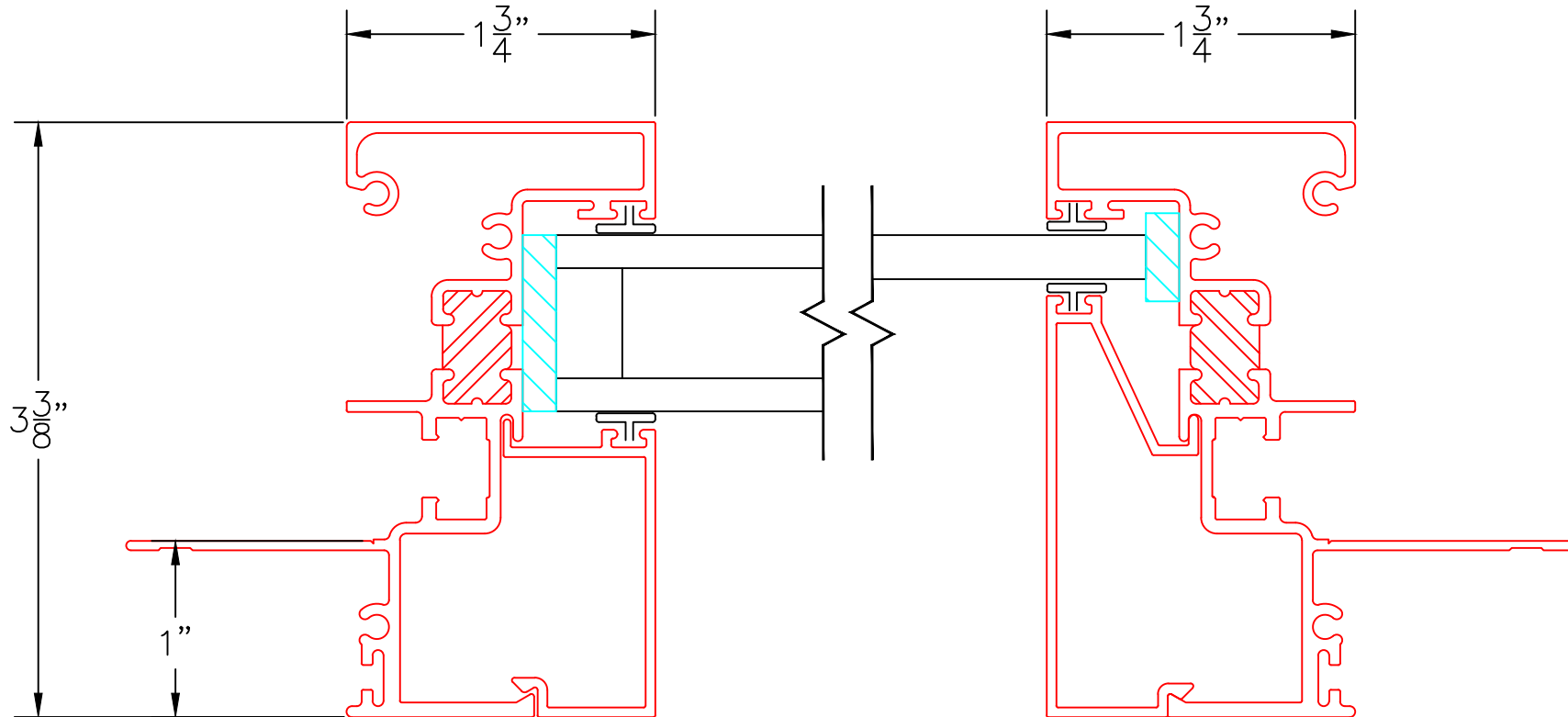

EXTERIOR

0 0.5 1  
(USE RULER TO SCALE DIMENSIONS IN INCHES)  
**SCALE: FULL**

GLAZED TO FRAME WINDOW DETAILS  
1/4" SINGLE AND 1" INSULATED  
GLAZING SHOWN

5A

0-0 GTF WITH  
JAMB MULLION

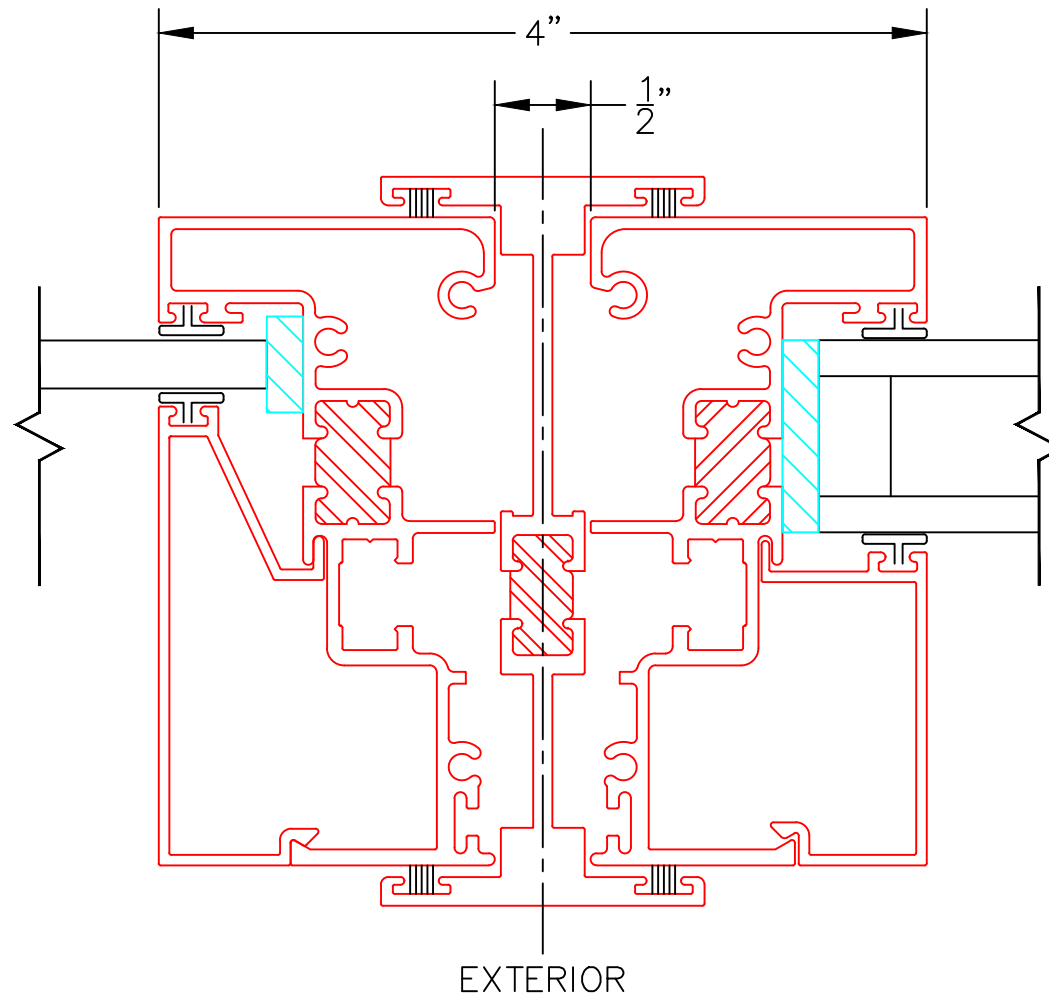



0 0.5 1  
(USE RULER TO SCALE DIMENSIONS IN INCHES)  
**SCALE: FULL**

GLAZED TO FRAME WINDOW DETAILS  
1/4" SINGLE AND 1" INSULATED  
GLAZING SHOWN

EXTERIOR

7

ALTERNATE  
STACK BAR

