

(USE RULER TO SCALE DIMENSIONS IN INCHES)
SCALE: 1/4

SINGLE HUNG WINDOW DETAILS
1" INSULATED GLAZING

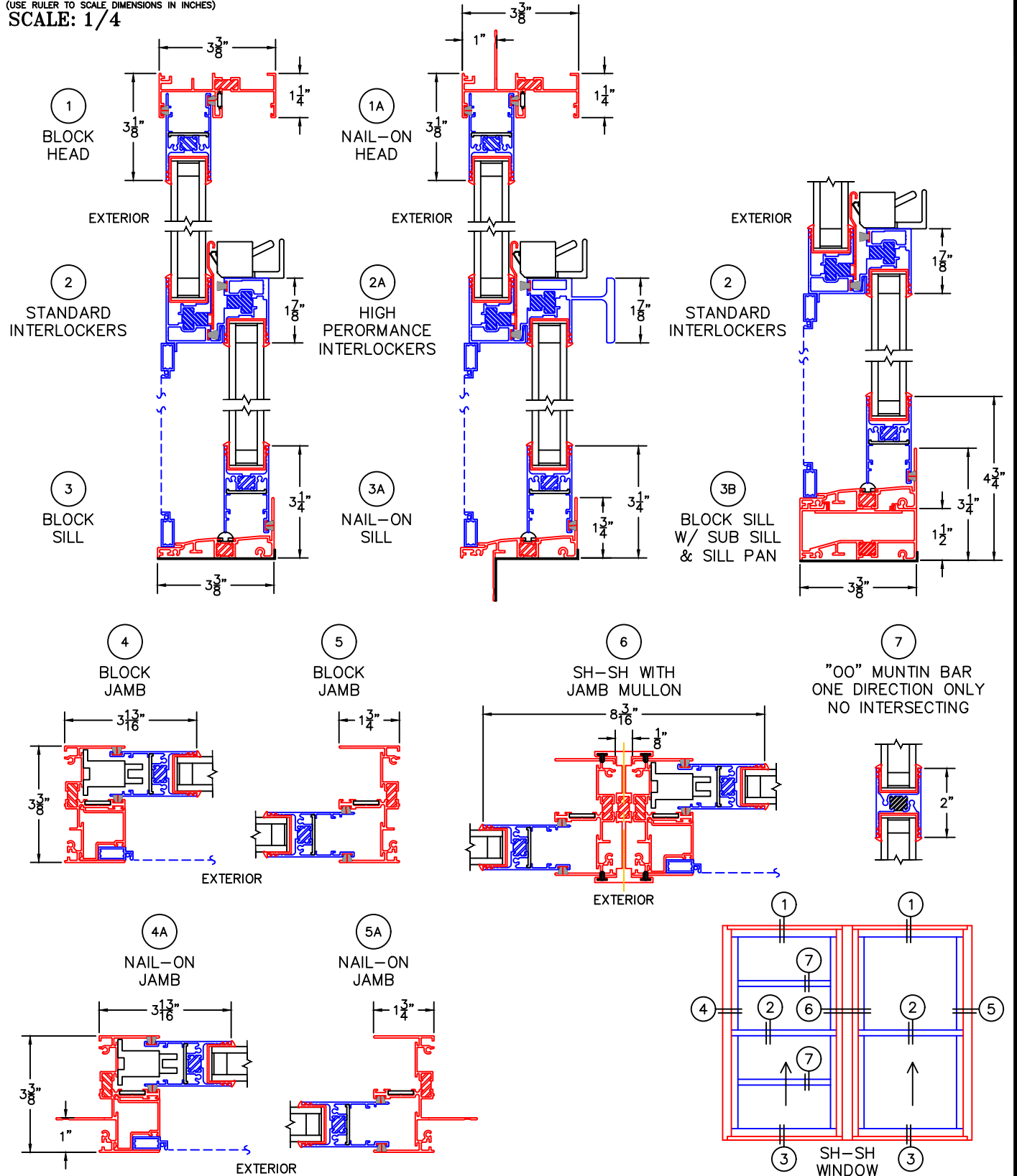

GLASS PENETRATION FOR 1" GLASS: 9/16"

0 0.5 1
(USE RULER TO SCALE DIMENSIONS IN INCHES)
SCALE: FULL

SINGLE HUNG WINDOW DETAILS
1" INSULATED GLAZING

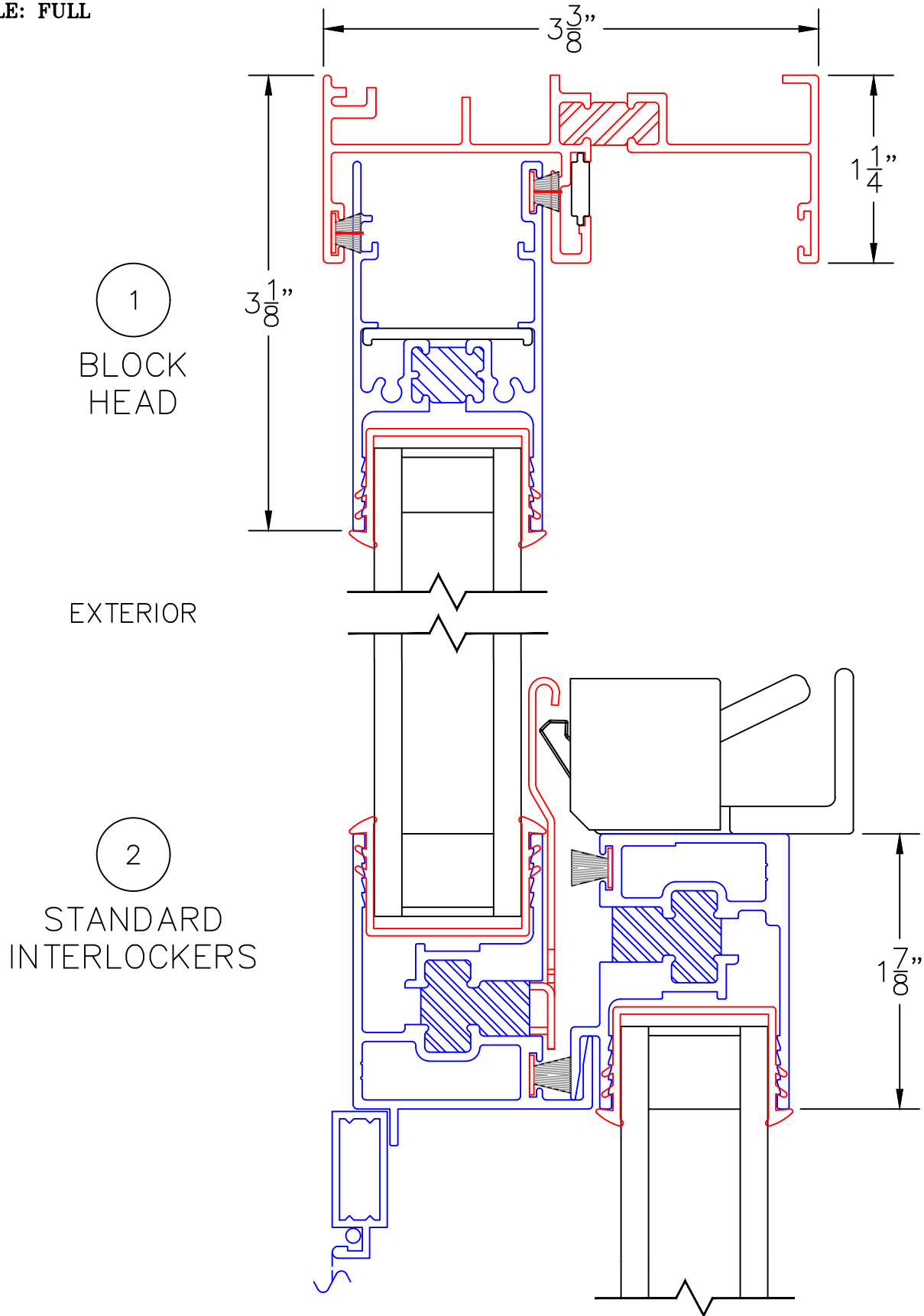

1
BLOCK
HEAD

EXTERIOR

2
STANDARD
INTERLOCKERS

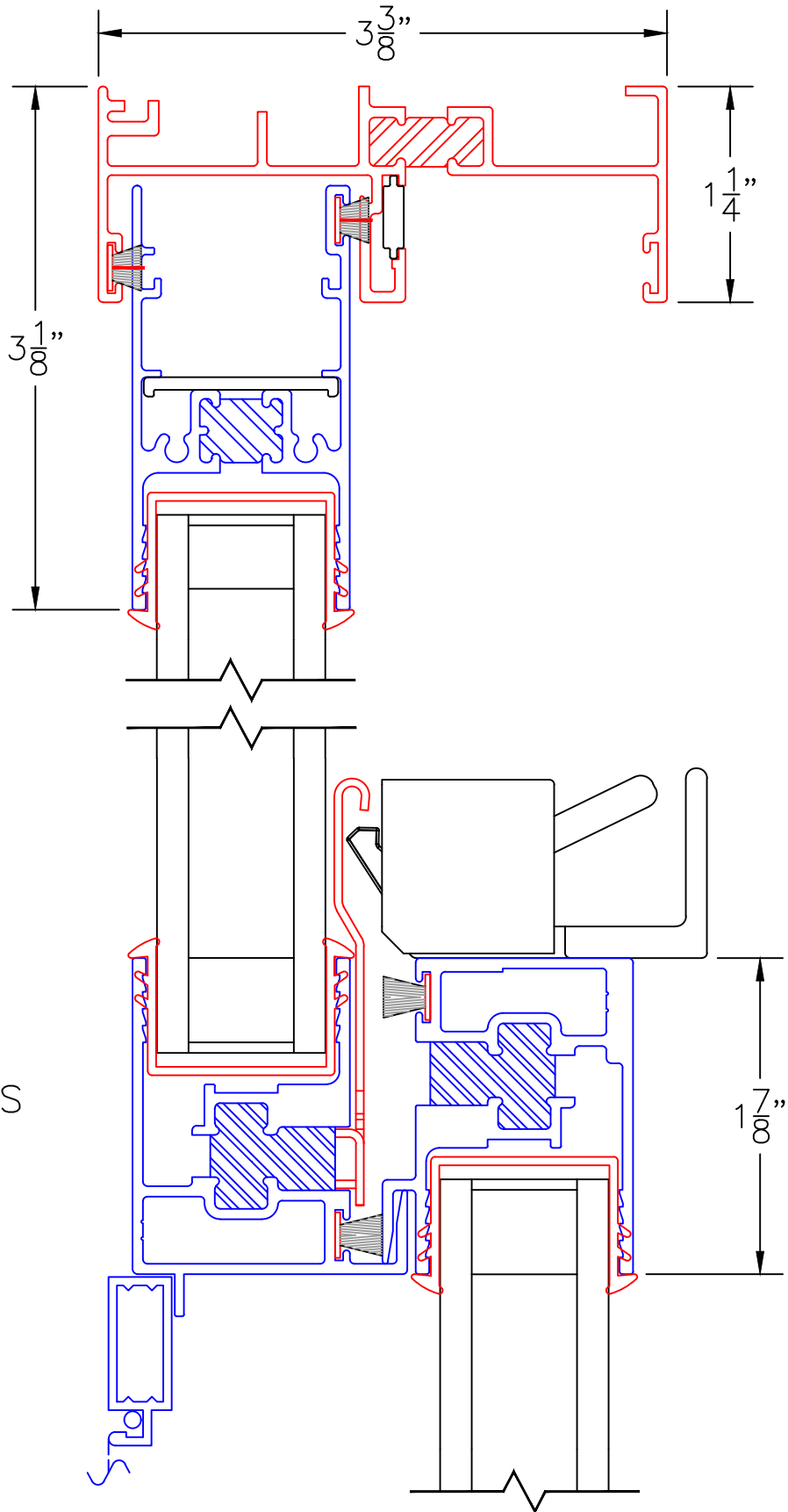

0 0.5 1
(USE RULER TO SCALE DIMENSIONS IN INCHES)
SCALE: FULL

SINGLE HUNG WINDOW DETAILS
1" INSULATED GLAZING

1A
NAIL-ON
HEAD

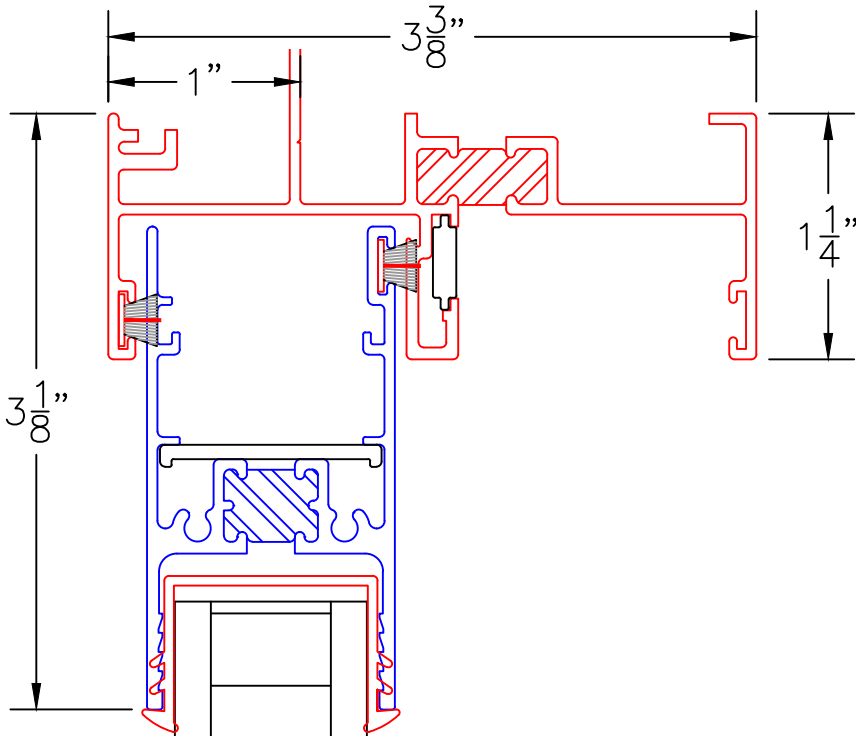

EXTERIOR

2A
HIGH
PERFORMANCE
INTERLOCKERS

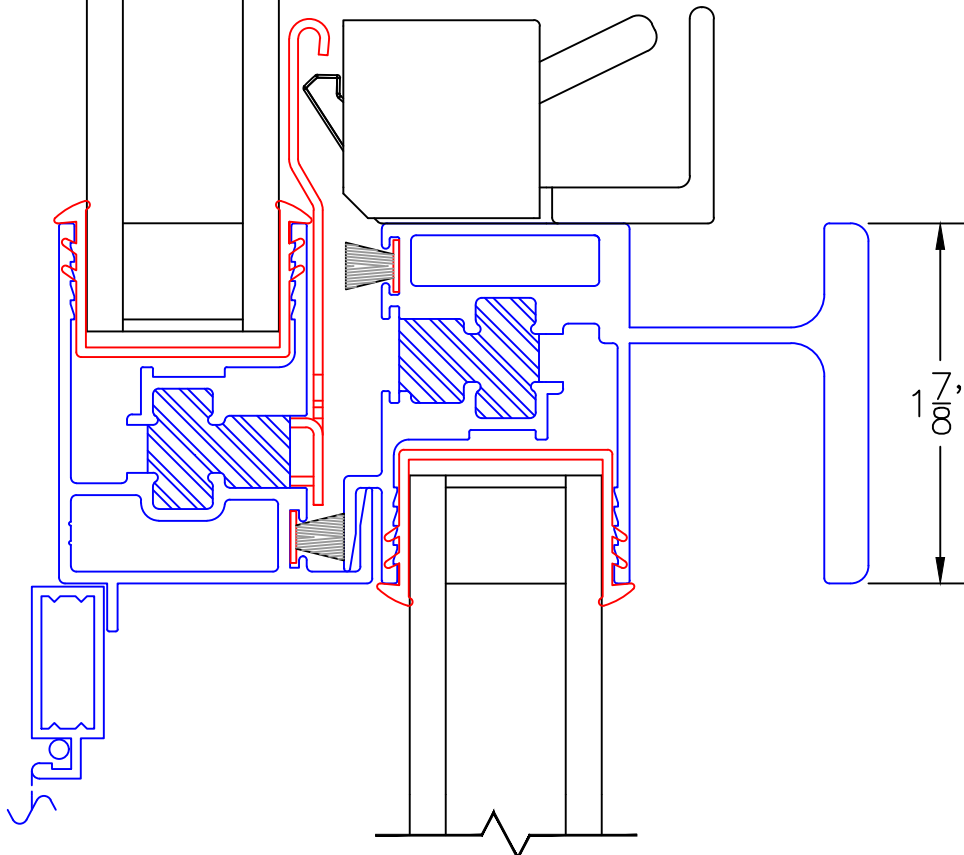

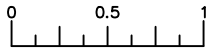

(USE RULER TO SCALE DIMENSIONS IN INCHES)

SCALE: FULL

SINGLE HUNG WINDOW DETAILS
1" INSULATED GLAZING

EXTERIOR

3

BLOCK
SILL

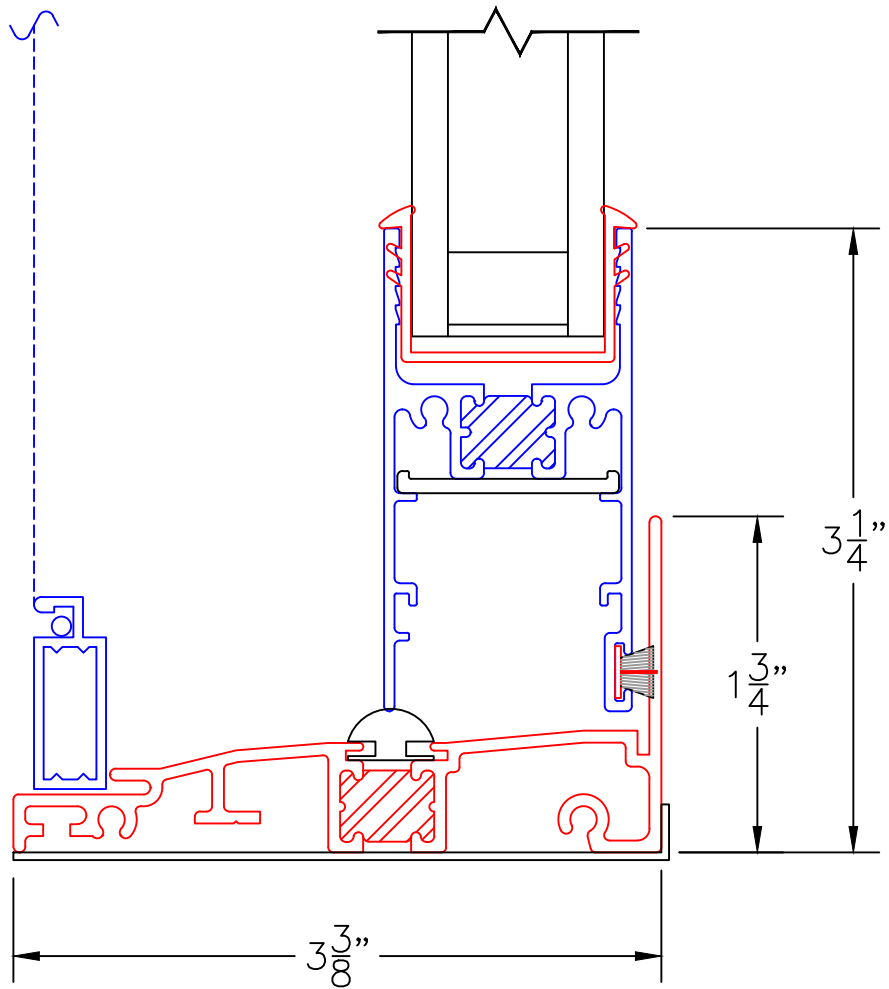

0 0.5 1
(USE RULER TO SCALE DIMENSIONS IN INCHES)
SCALE: FULL

SINGLE HUNG WINDOW DETAILS
1" INSULATED GLAZING

EXTERIOR

3A
NAIL-ON
SILL

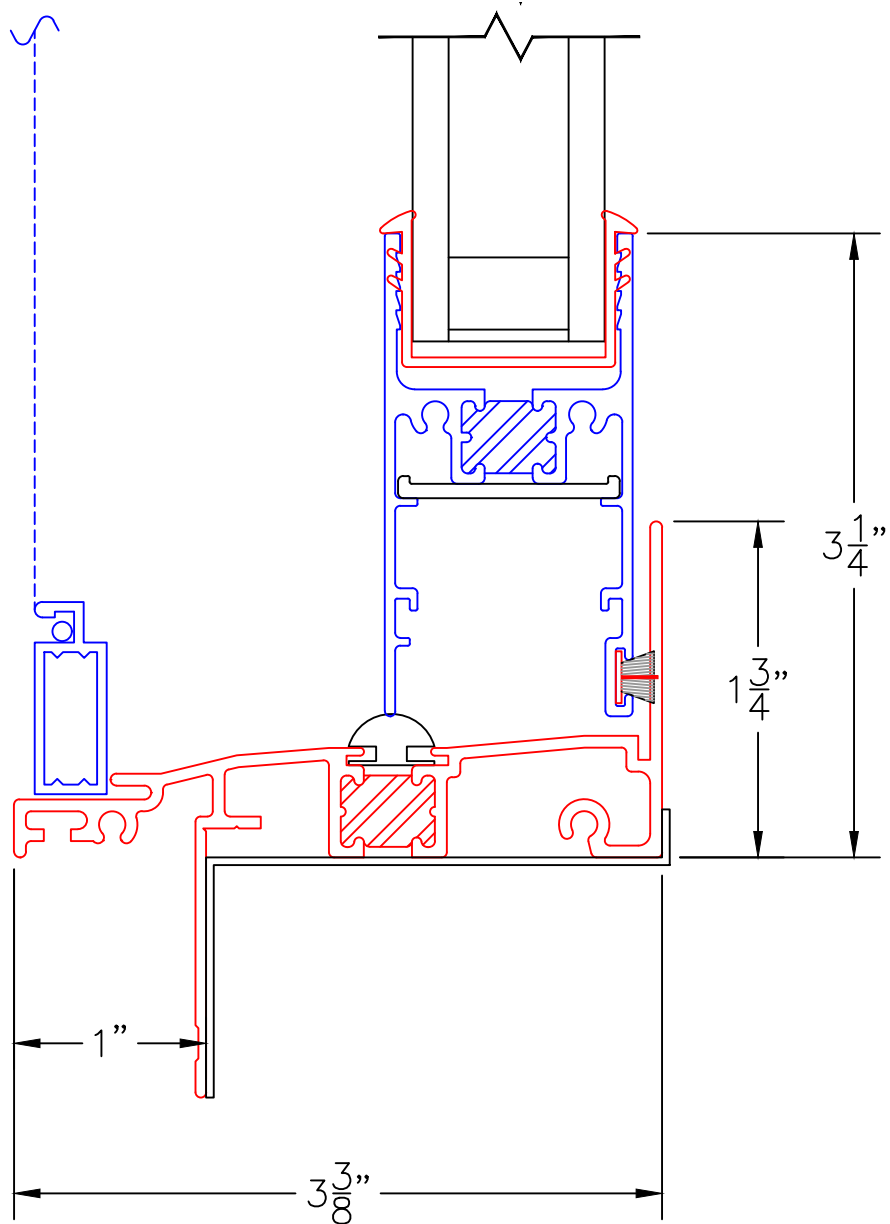

0 0.5 1
(USE RULER TO SCALE DIMENSIONS IN INCHES)
SCALE: FULL

SINGLE HUNG WINDOW DETAILS
1" INSULATED GLAZING

EXTERIOR

3B
BLOCK SILL
W/ SUB-SILL
& SILL PAN

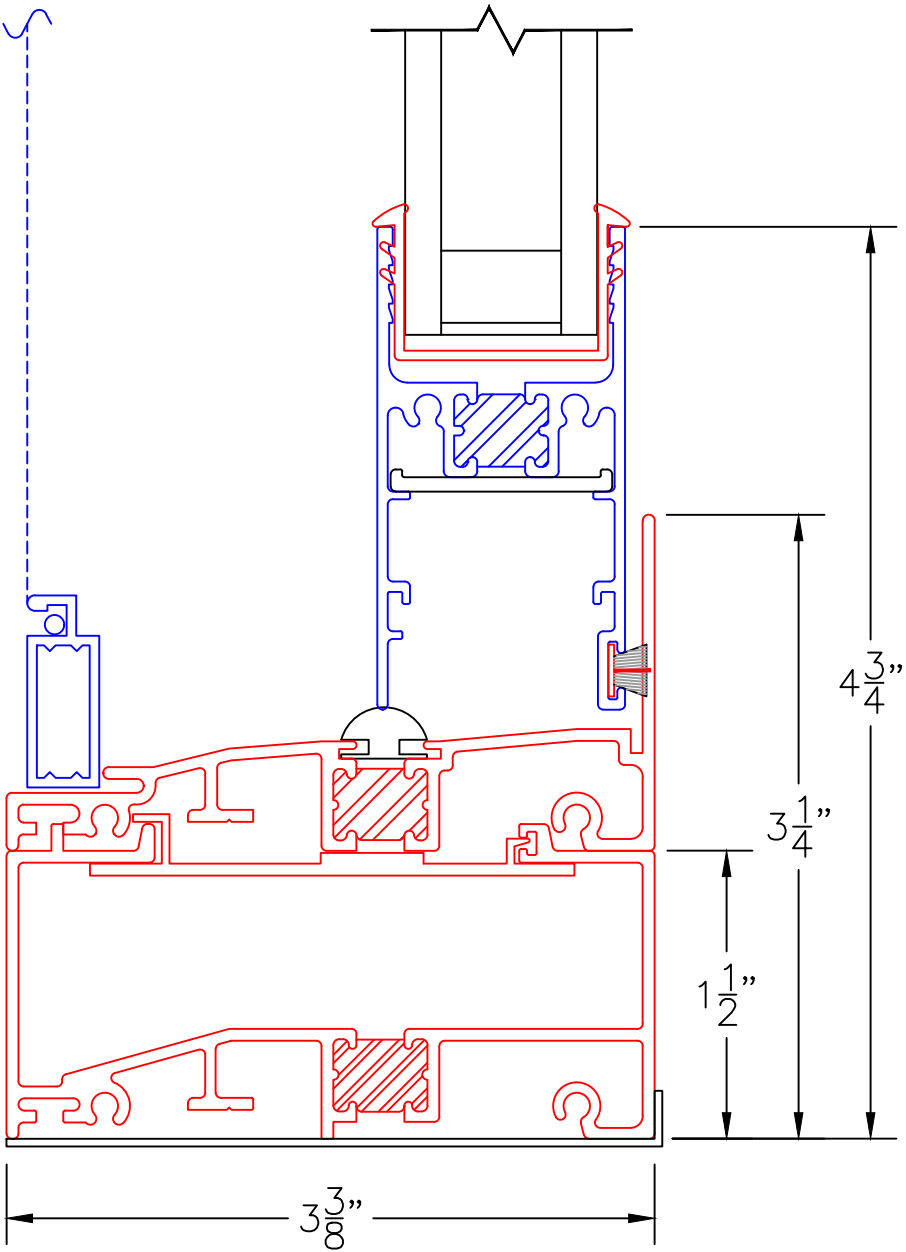

SINGLE HUNG WINDOW DETAILS 1" INSULATED GLAZING

0 0.5 1
(USE RULER TO SCALE DIMENSIONS IN INCHES)
SCALE: FULL

4

BLOCK
JAMB

5

BLOCK
JAMB

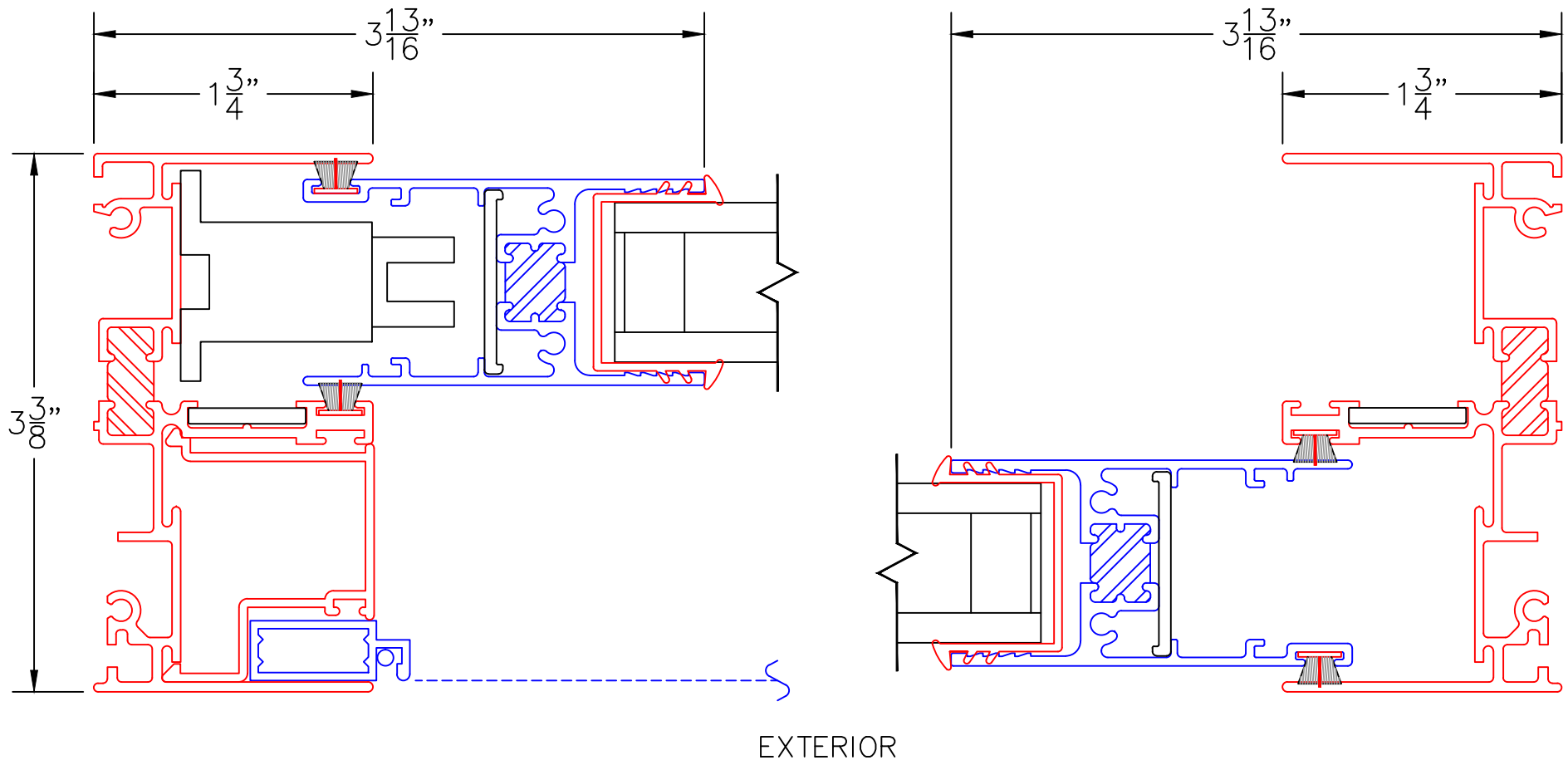

SINGLE HUNG WINDOW DETAILS 1" INSULATED GLAZING

0 0.5 1
(USE RULER TO SCALE DIMENSIONS IN INCHES)
SCALE: FULL

4A

NAIL-ON
JAMB

5A

NAIL-ON
JAMB

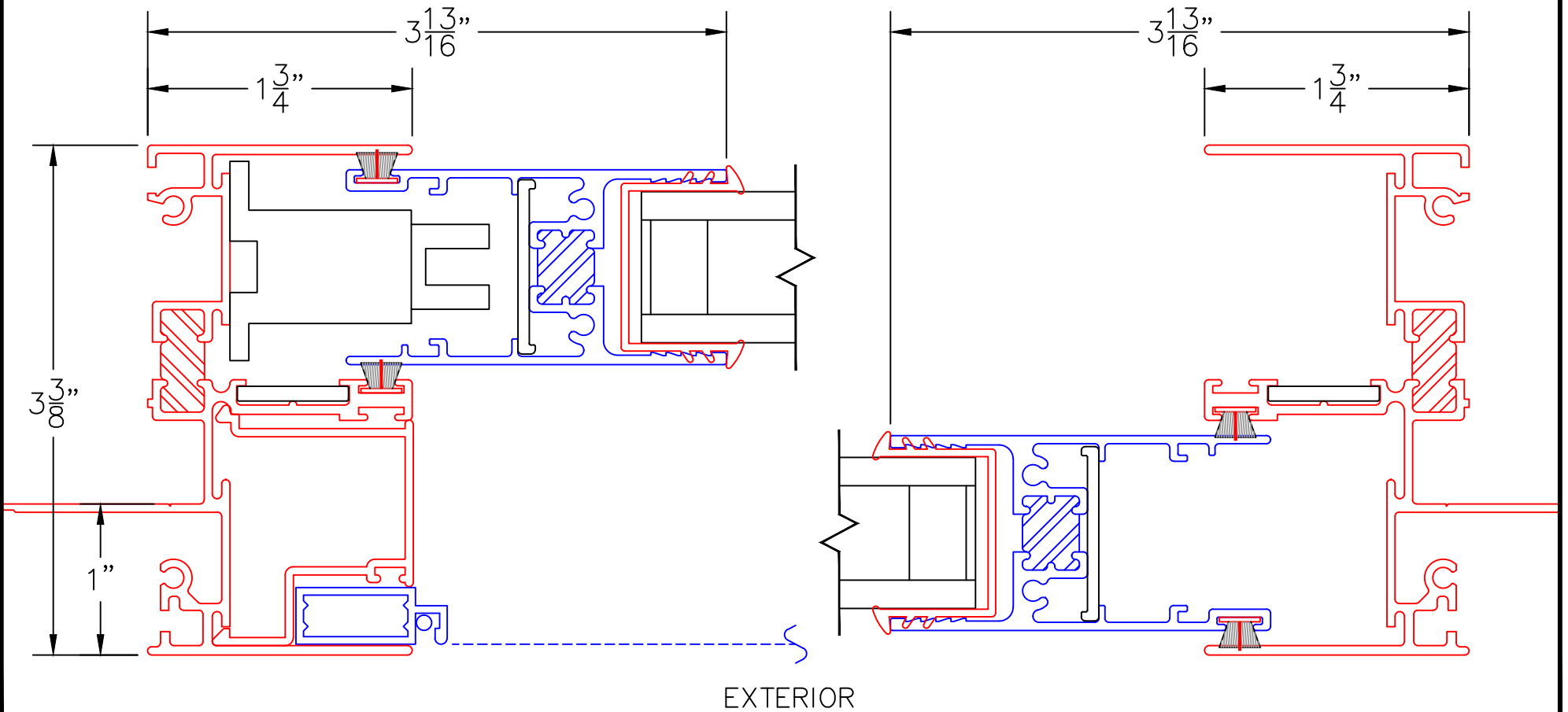

SINGLE HUNG WINDOW DETAILS 1" INSULATED GLAZING

0 0.5 1
(USE RULER TO SCALE DIMENSIONS IN INCHES)
SCALE: FULL

6

SH-SH WITH
JAMB MULLION

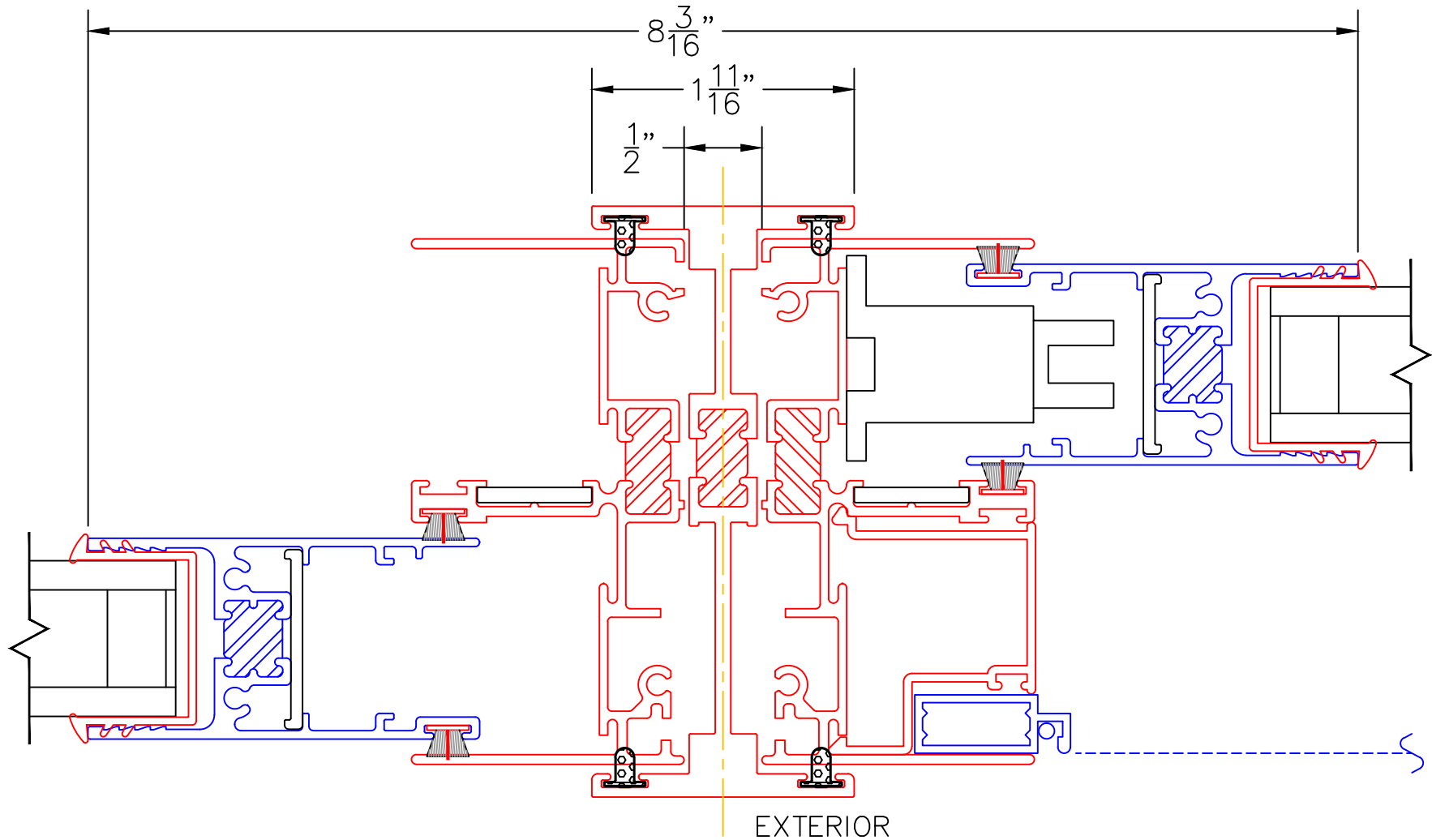

0 0.5 1
(USE RULER TO SCALE DIMENSIONS IN INCHES)
SCALE: FULL

SINGLE HUNG WINDOW DETAILS
1" INSULATED GLAZING

7

"00" MUNTIN BAR
ONE DIRECTION ONLY
NO INTERSECTING

