

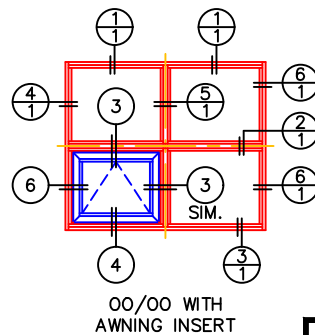

3800-T FIXED WINDOW DETAILS WITH 450-T CASEMENT AND AWNING INSERTS

(USE RULER TO SCALE DIMENSIONS IN INCHES)
SCALE: 1/4

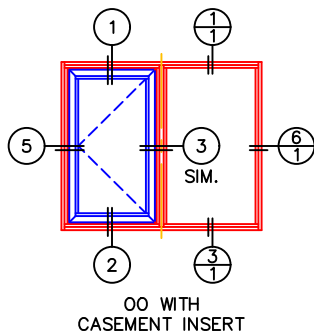
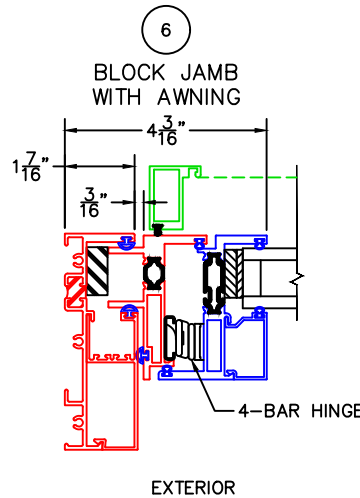
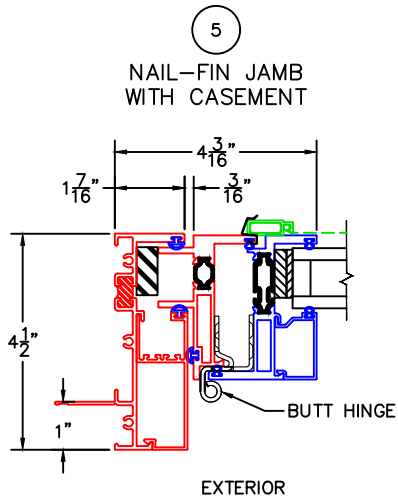
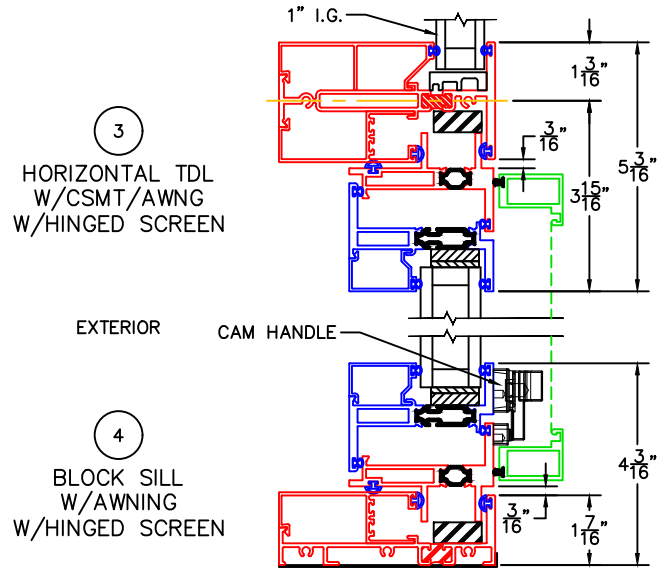
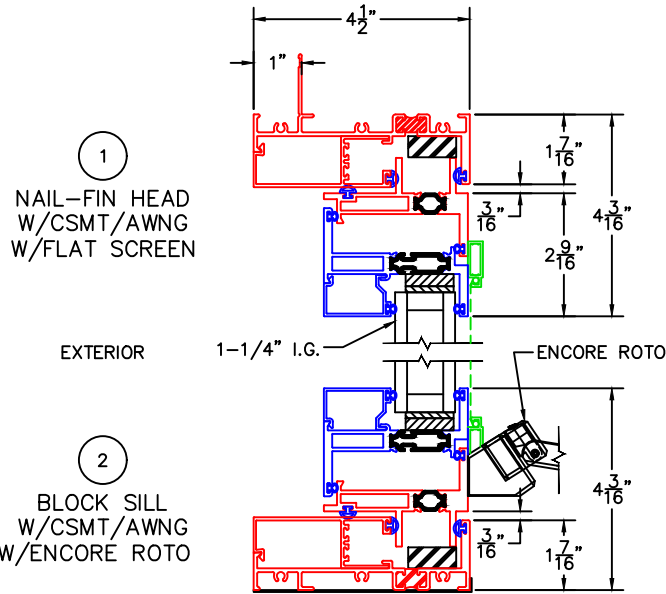

-GLASS PENETRATION: 3800-T = 9/16"; 450-T = 1/2"
-EXTERIOR RATED PRODUCTS HAVE WEEP SLOTS ON HORIZONTAL SILLS.

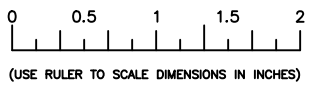

SCALE: 3:4

FIXED WINDOW DETAILS WITH 450-T INSERT

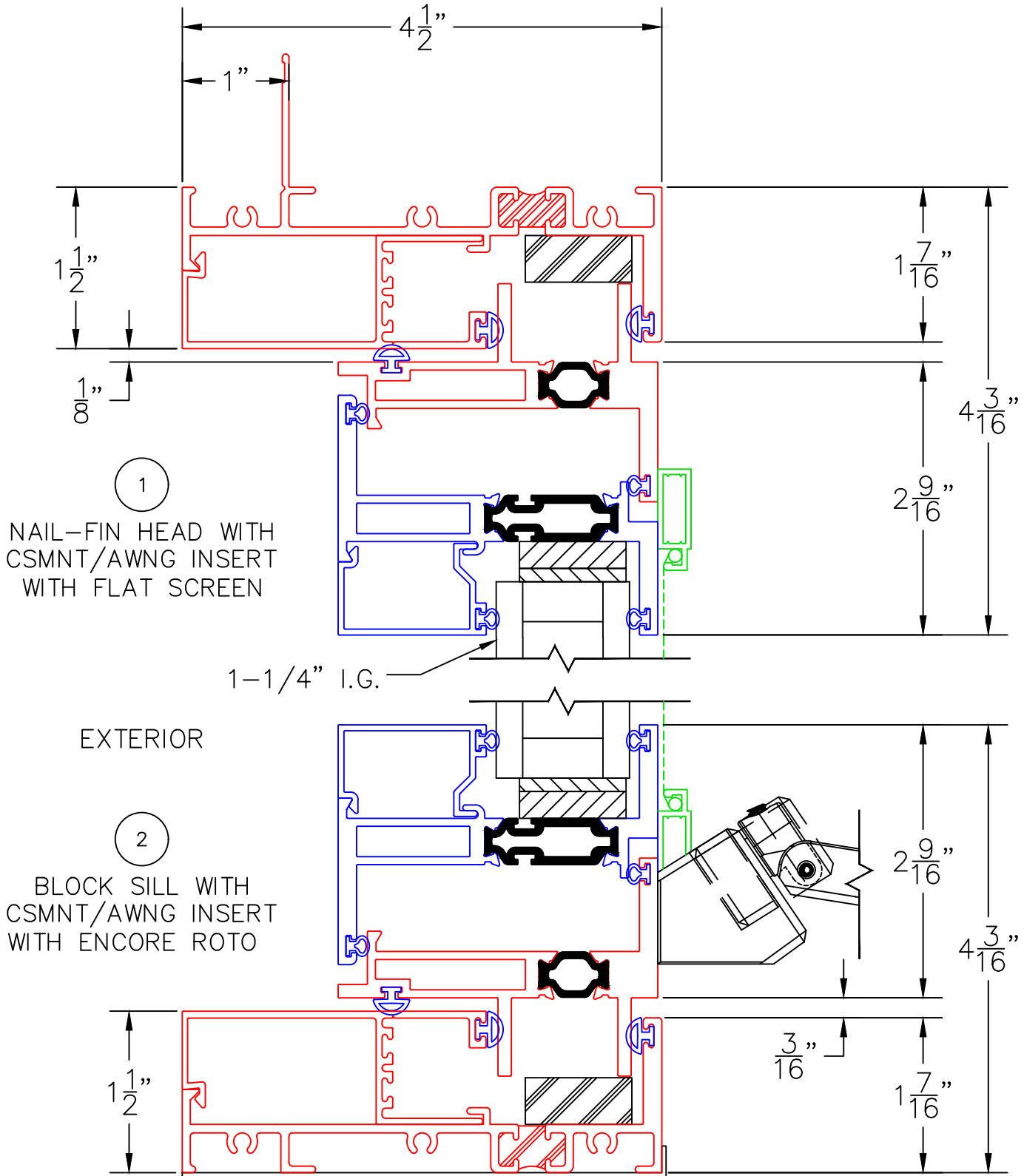

1

NAIL-FIN HEAD WITH CSMNT/AWNG INSERT WITH FLAT SCREEN

EXTERIOR

2

BLOCK SILL WITH CSMNT/AWNG INSERT WITH ENCORE ROTO

1-1/4" I.G.

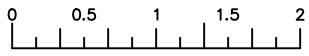

(USE RULER TO SCALE DIMENSIONS IN INCHES)

SCALE: 3:4

**FIXED WINDOW DETAILS
WITH 450-T INSERT**

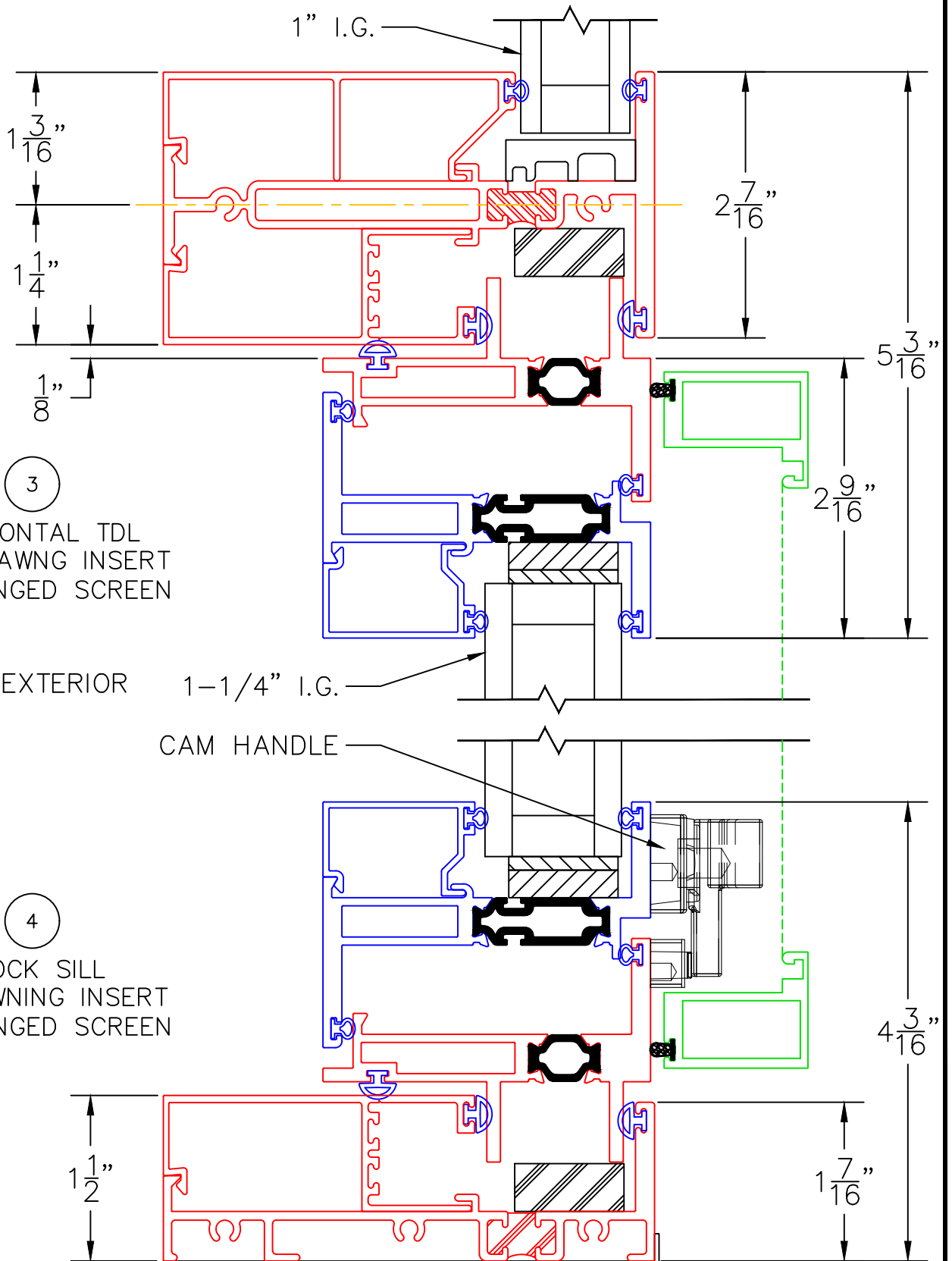

3

HORIZONTAL TDL
CSMNT/AWNG INSERT
WITH HINGED SCREEN

4

BLOCK SILL
WITH AWNING INSERT
WITH HINGED SCREEN

0 0.5 1
(USE RULER TO SCALE DIMENSIONS IN INCHES)
SCALE: 1:1

**FIXED WINDOW DETAILS
WITH 450-T INSERT**

5

**NAIL-FIN JAMB WITH
CASEMENT INSERT**

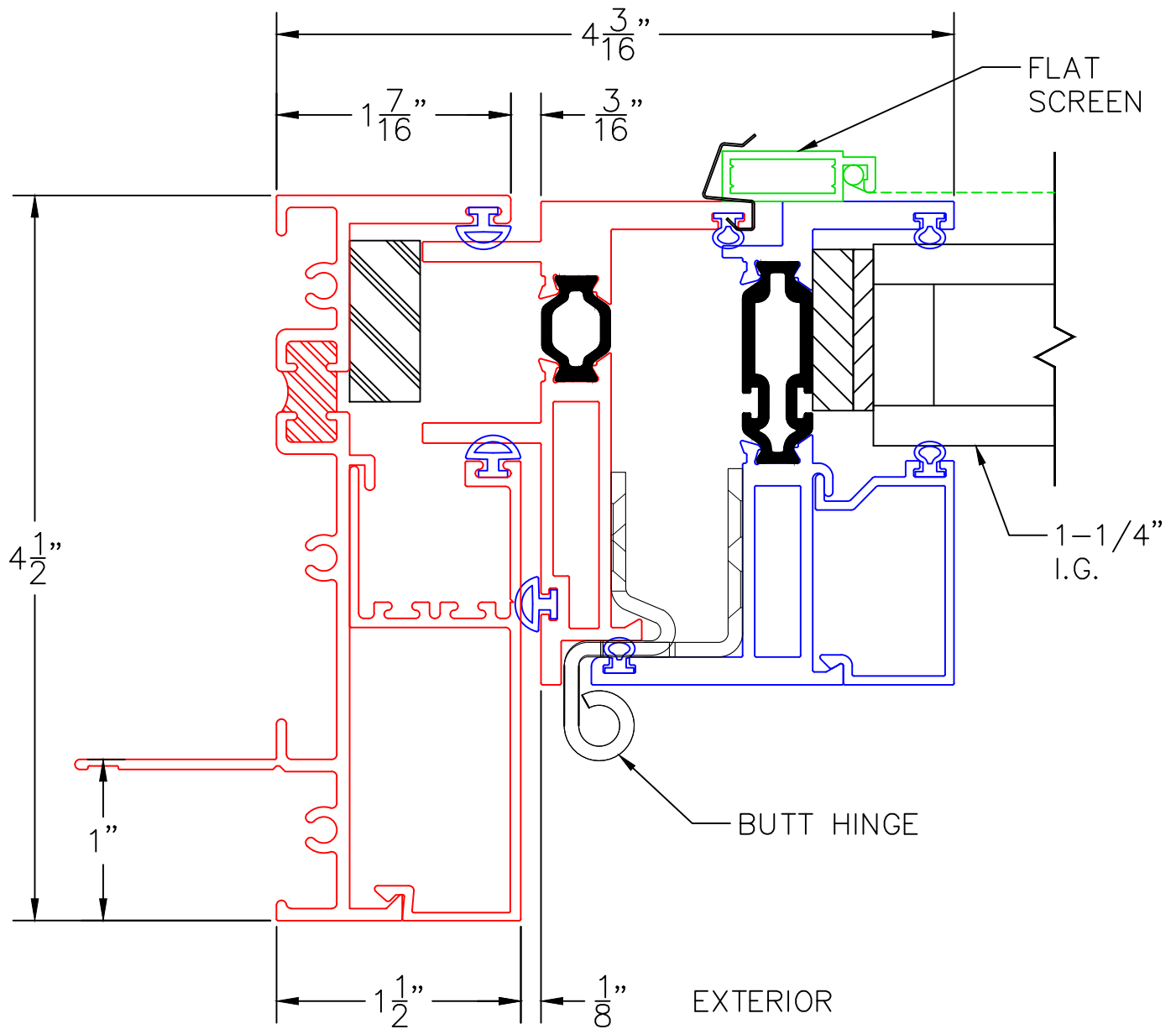

0 0.5 1
(USE RULER TO SCALE DIMENSIONS IN INCHES)
SCALE: 1:1

**FIXED WINDOW DETAILS
WITH 450-T INSERT**

6

**BLOCK JAMB WITH
AWNING INSERT
WITH HINGED SCREEN**

