



DOOR PANEL INSERTS

Product Specifications  
[Click Here](#)

(USE RULER TO SCALE DIMENSIONS IN INCHES)  
SCALE: 1/4"

1  
BLOCK HEAD  
W/3070-T  
INSERT

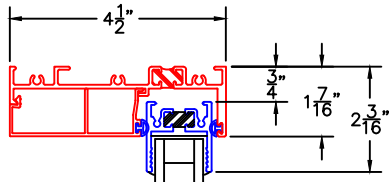

EXTERIOR

1A  
BLOCK HEAD  
W/3000-T  
INSERT

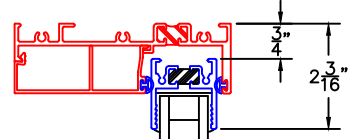

EXTERIOR

2  
BLOCK SILL  
W/3070-T  
INSERT

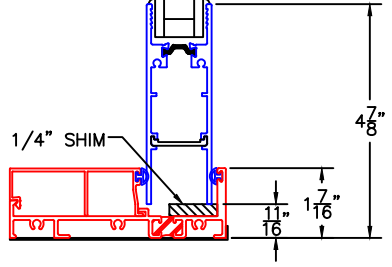

SERIES 3070-T

2A  
BLOCK SILL  
W/3000-T  
INSERT

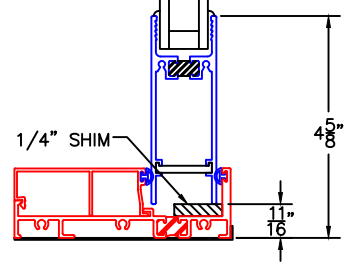

SERIES 3300-T

3  
BLOCK JAMB  
W/NARROW STILE INSERT

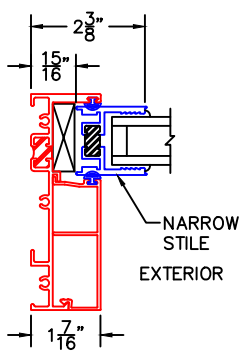

NARROW STILE  
EXTERIOR

3A  
BLOCK JAMB  
W/ARCHETYPE NARROW STILE INSERT

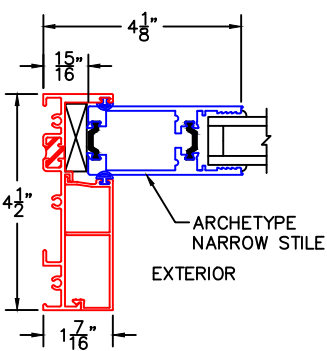

ARCHETYPE NARROW STILE  
EXTERIOR

3B  
BLOCK JAMB  
W/ARCHETYPE STILE INSERT

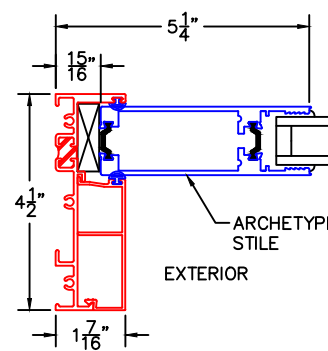

ARCHETYPE STILE  
EXTERIOR

4  
VERTICAL TDL  
W/NARROW STILE INSERT

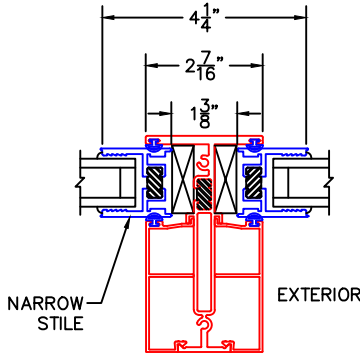

NARROW STILE  
EXTERIOR

4A  
VERTICAL TDL  
W/ARCHETYPE NARROW STILE INSERT

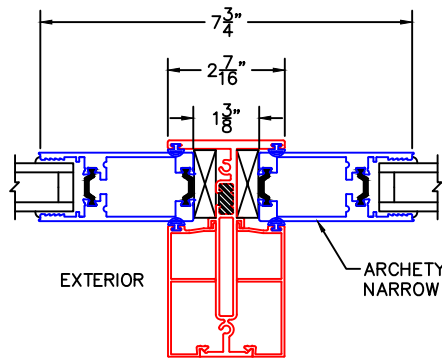

EXTERIOR  
ARCHETYPE NARROW STILE

4B  
VERTICAL TDL  
W/ARCHETYPE STILE INSERT

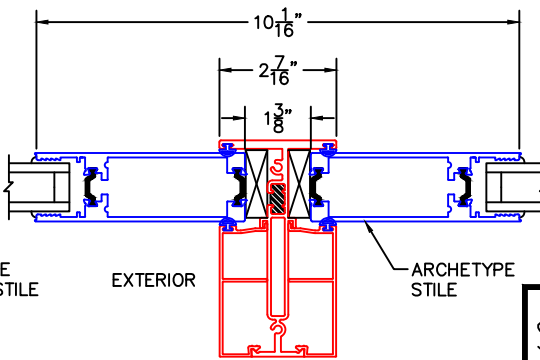

EXTERIOR  
ARCHETYPE STILE

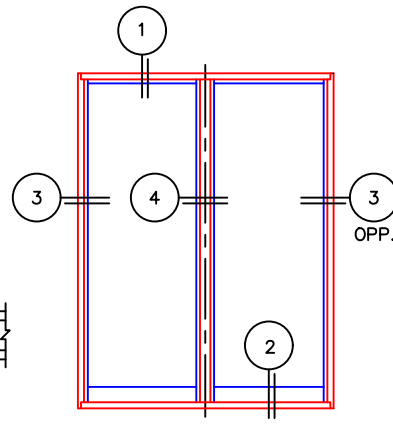

SERIES 3800-T

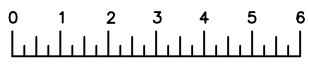

(USE RULER TO SCALE DIMENSIONS IN INCHES)  
SCALE: 1/4

## DOOR PANEL INSERTS

[Architecturals Click Here](#)   [Parts List Click Here](#)

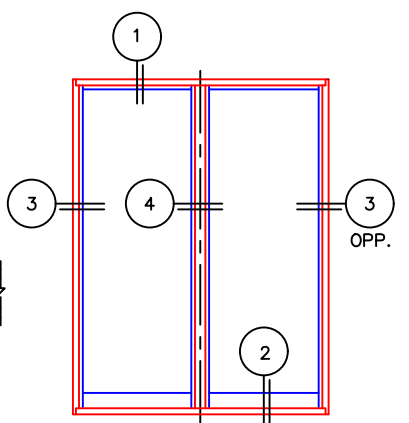
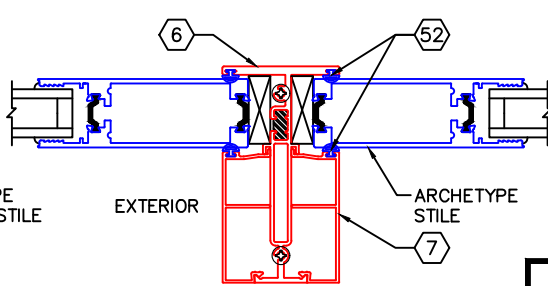
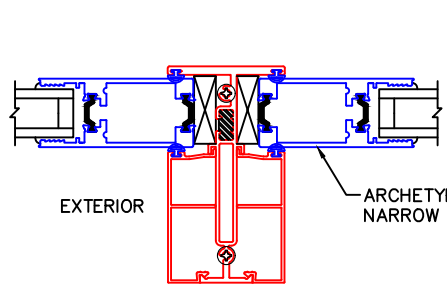
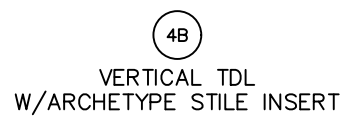
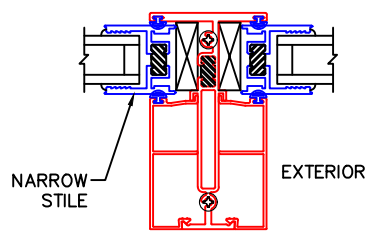
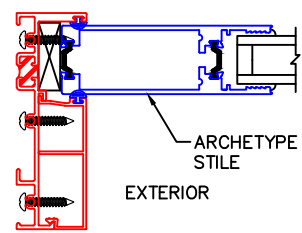
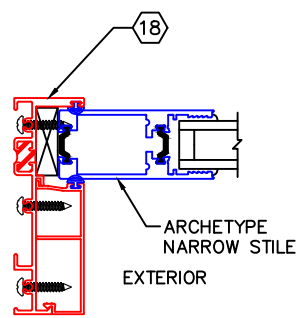
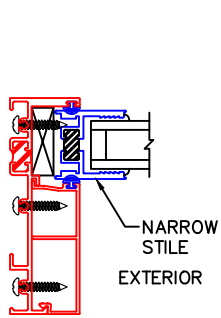
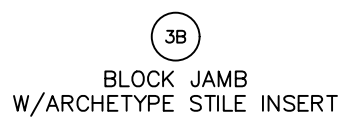
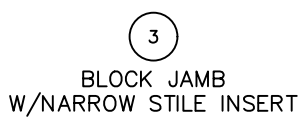
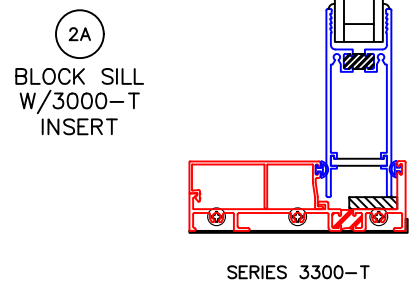
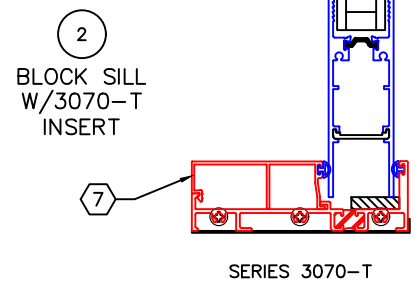
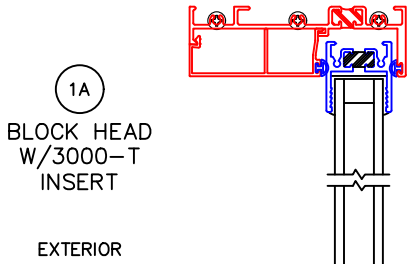
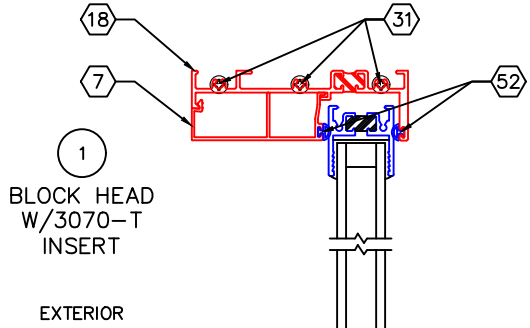

DOOR PANEL INSERT DETAILS  
1" GLAZING SHOWN

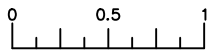

(USE RULER TO SCALE DIMENSIONS IN INCHES)

SCALE: FULL

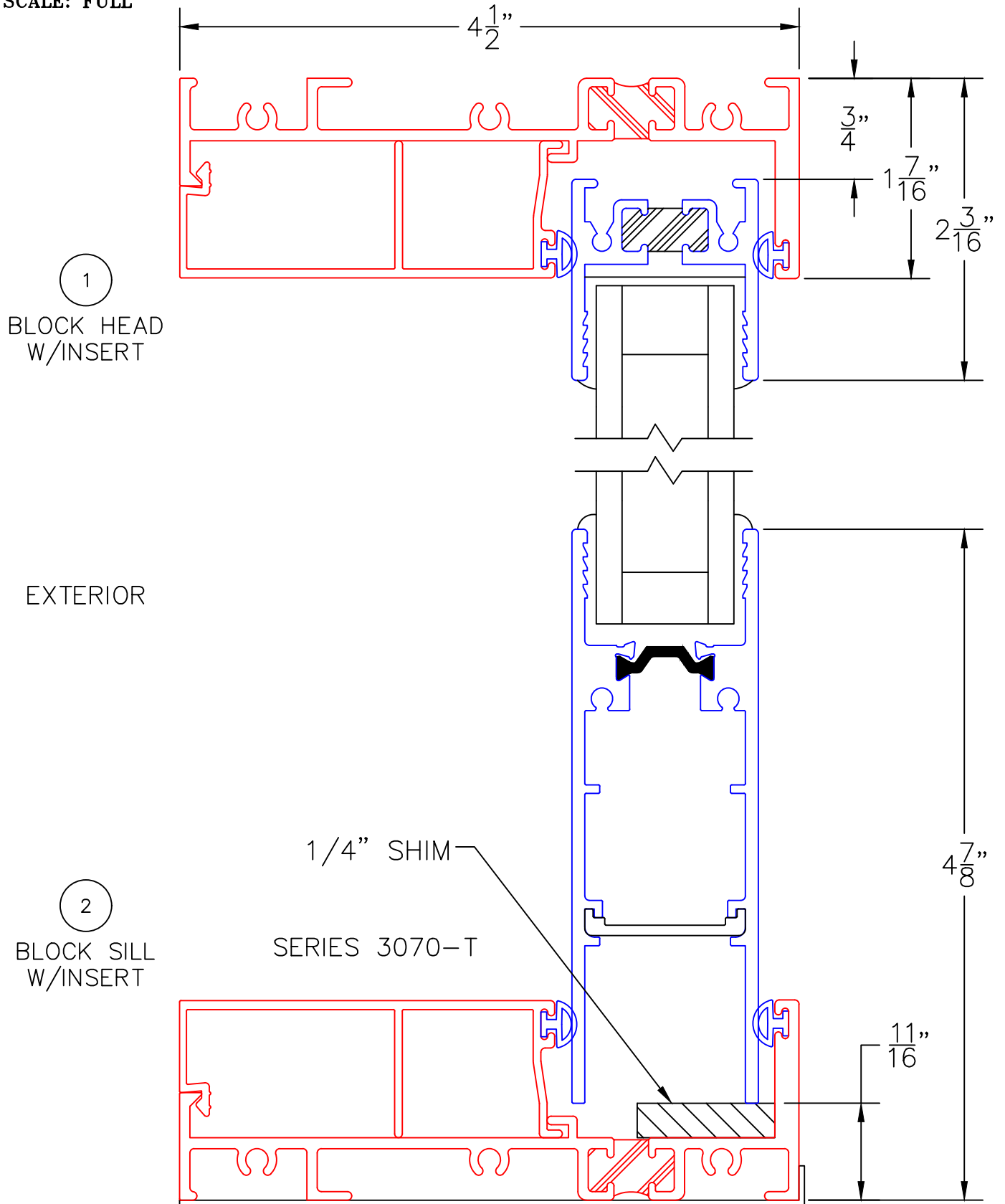

1

BLOCK HEAD  
W/INSERT

EXTERIOR

2

BLOCK SILL  
W/INSERT

1/4" SHIM

SERIES 3070-T

4 1/2"

3/4"

1 7/16"

2 3/16"

4 7/8"

11/16"

DOOR PANEL INSERT DETAILS  
1" GLAZING SHOWN

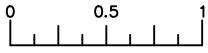

(USE RULER TO SCALE DIMENSIONS IN INCHES)

SCALE: FULL

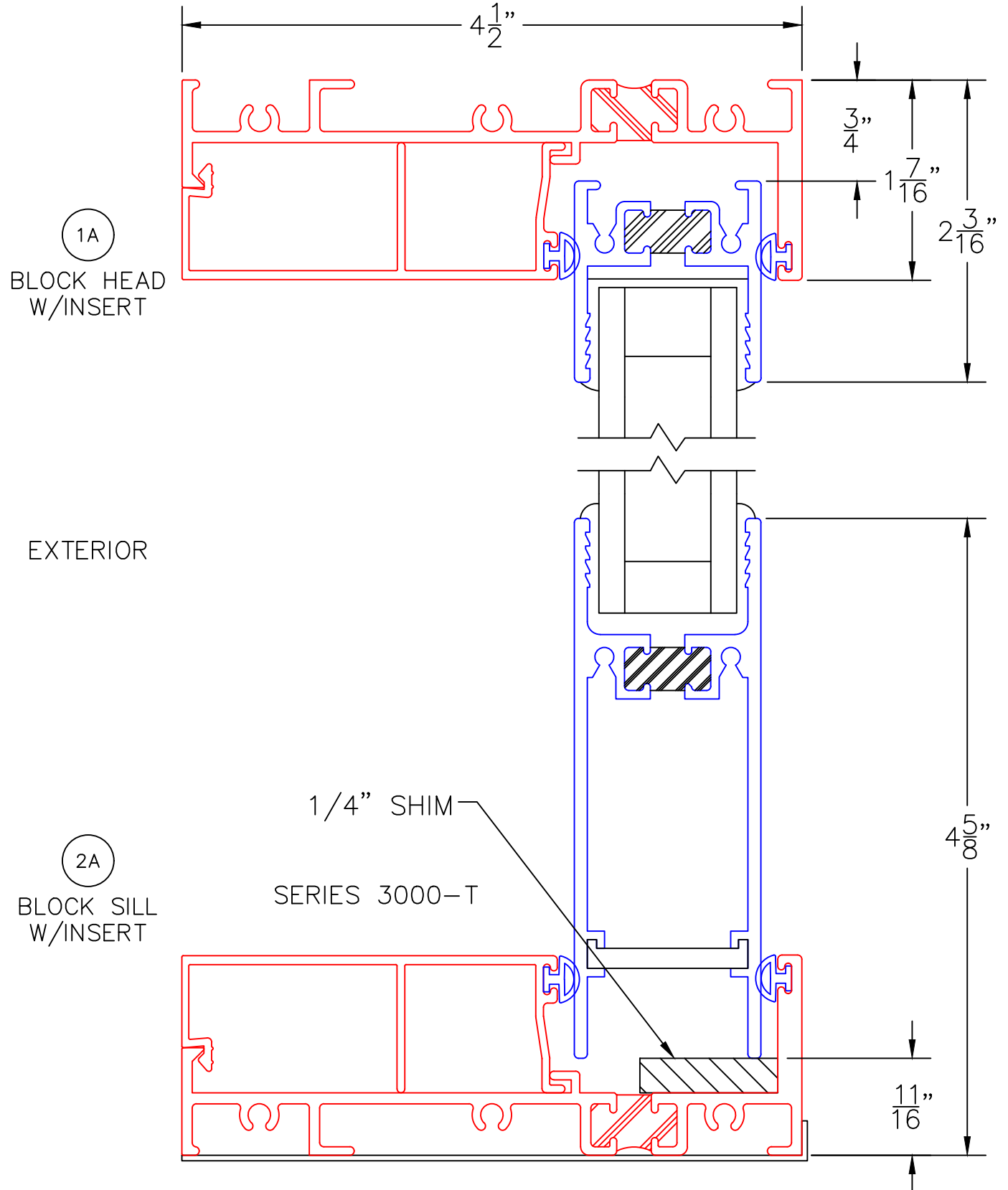

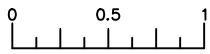

(USE RULER TO SCALE DIMENSIONS IN INCHES)

**SCALE: FULL**

DOOR PANEL INSERT DETAILS  
1" GLAZING SHOWN

3

BLOCK JAMB  
W/NARROW STILE INSERT  
(3070-T & 3000-T)

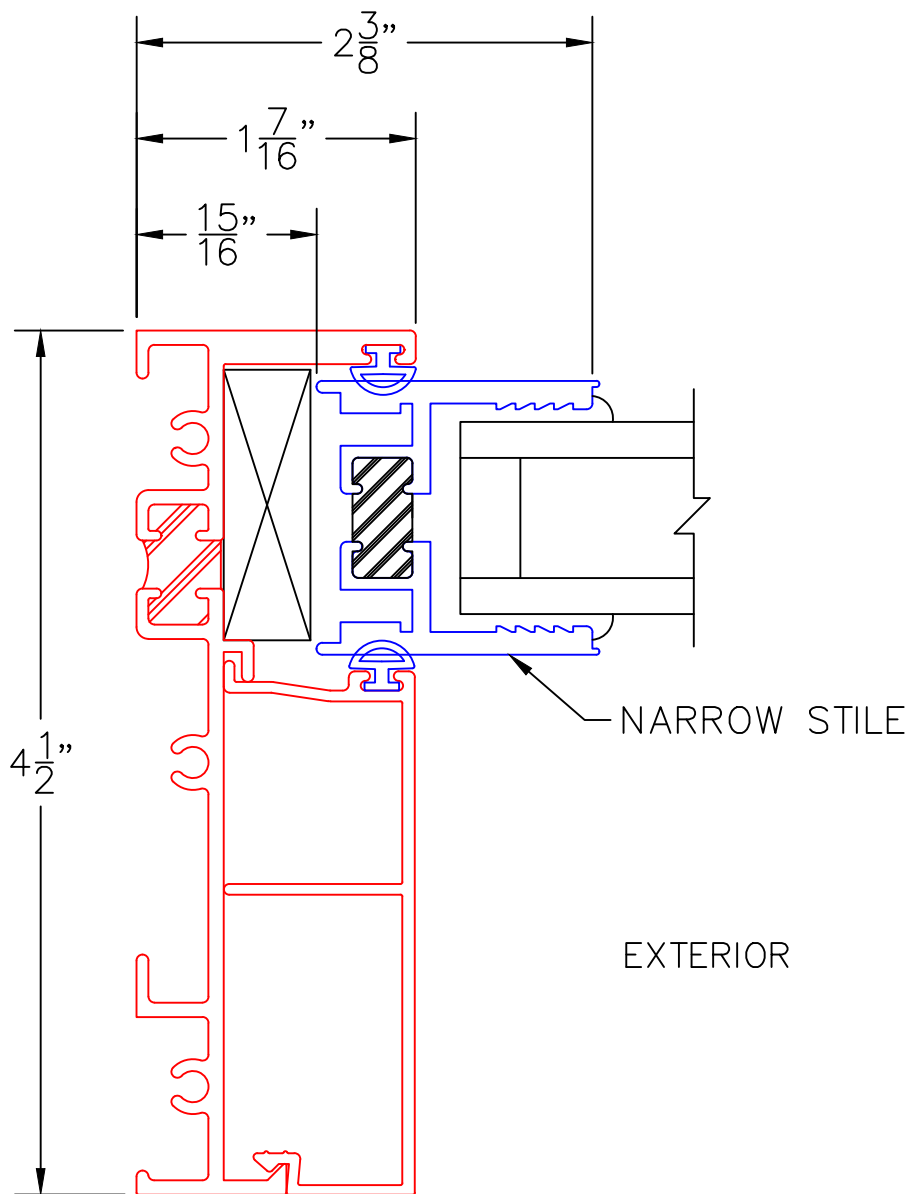

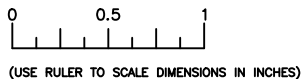

SCALE: FULL

DOOR PANEL INSERT DETAILS  
1" GLAZING SHOWN

3A

BLOCK JAMB  
W/ARCHETYPE NARROW STILE INSERT  
(3070-T & 3000-T)

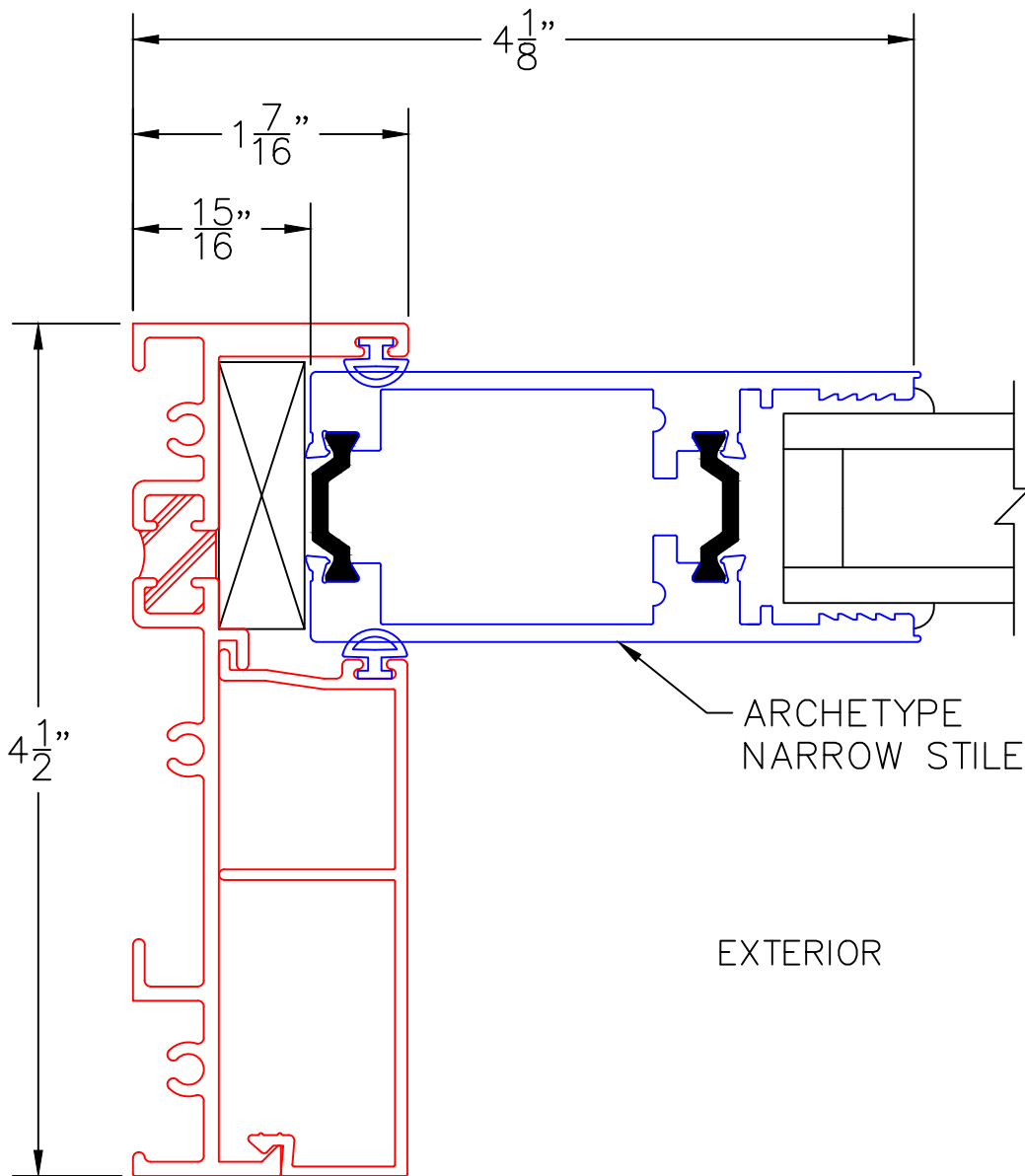

0 0.5 1  
(USE RULER TO SCALE DIMENSIONS IN INCHES)  
**SCALE: FULL**

DOOR PANEL INSERT DETAILS  
1" GLAZING SHOWN

3B

BLOCK JAMB  
W/ARCHETYPE STILE INSERT  
(3070-T & 3000-T)

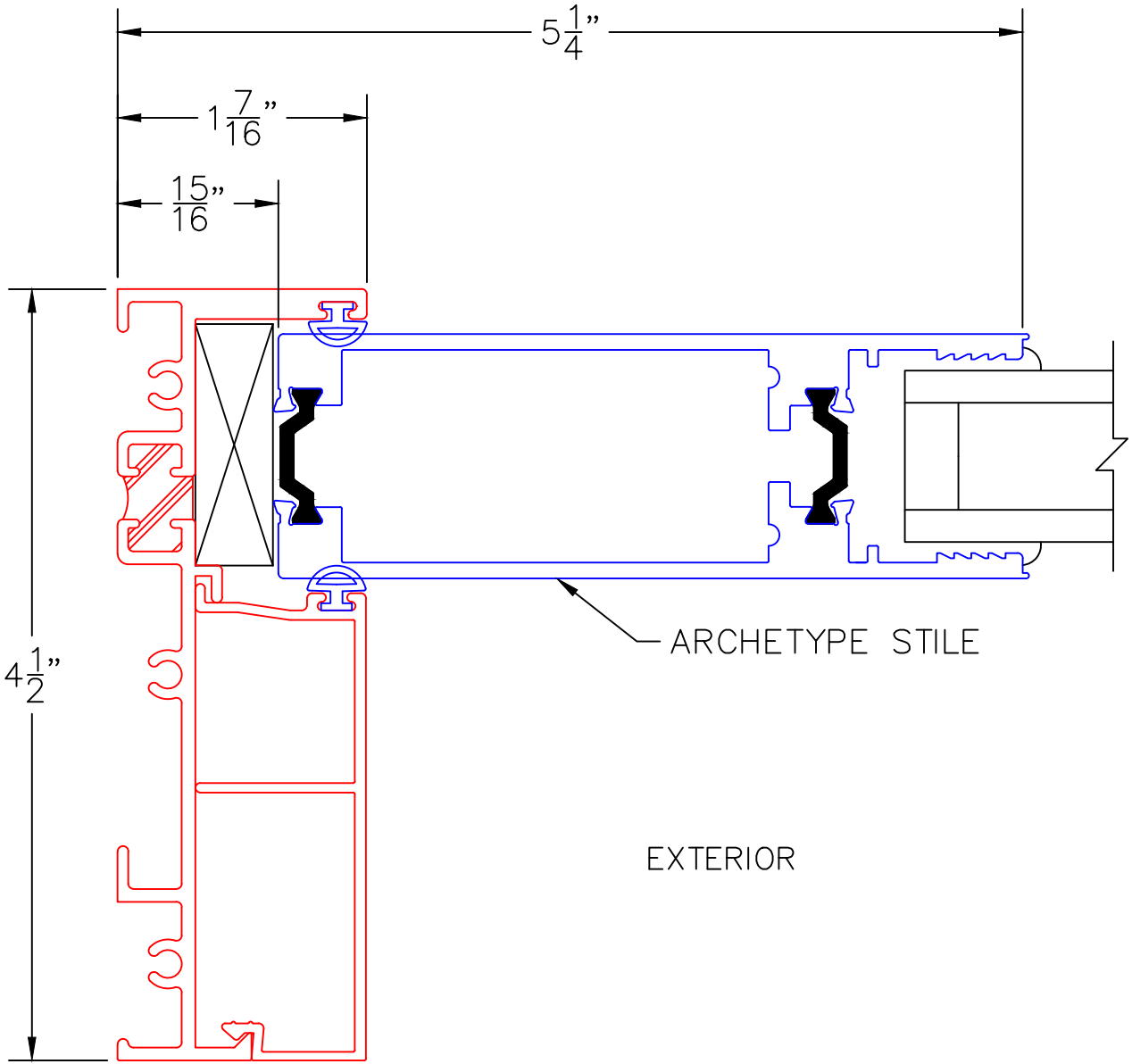

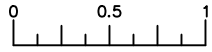

(USE RULER TO SCALE DIMENSIONS IN INCHES)

**SCALE: FULL**

### DOOR PANEL INSERT DETAILS 1" GLAZING SHOWN

4

VERTICAL TDL  
W/NARROW STILE INSERT  
(3070-T & 3000-T)

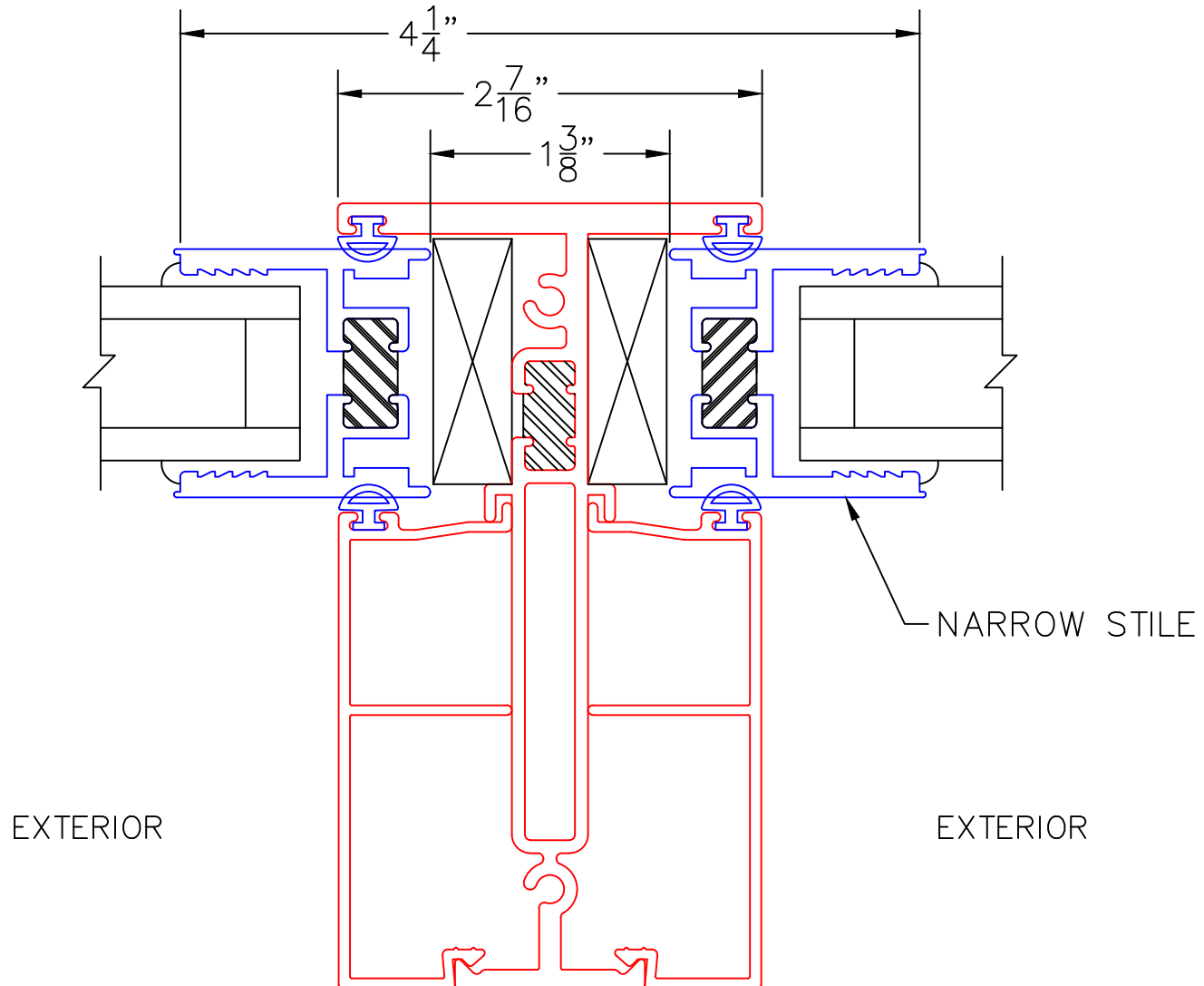



0 0.5 1  
(USE RULER TO SCALE DIMENSIONS IN INCHES)  
**SCALE: FULL**

DOOR PANEL INSERT DETAILS  
1" GLAZING SHOWN

4A

VERTICAL TDL  
W/ARCHETYPE NARROW STILE INSERT  
(3070-T & 3000-T)

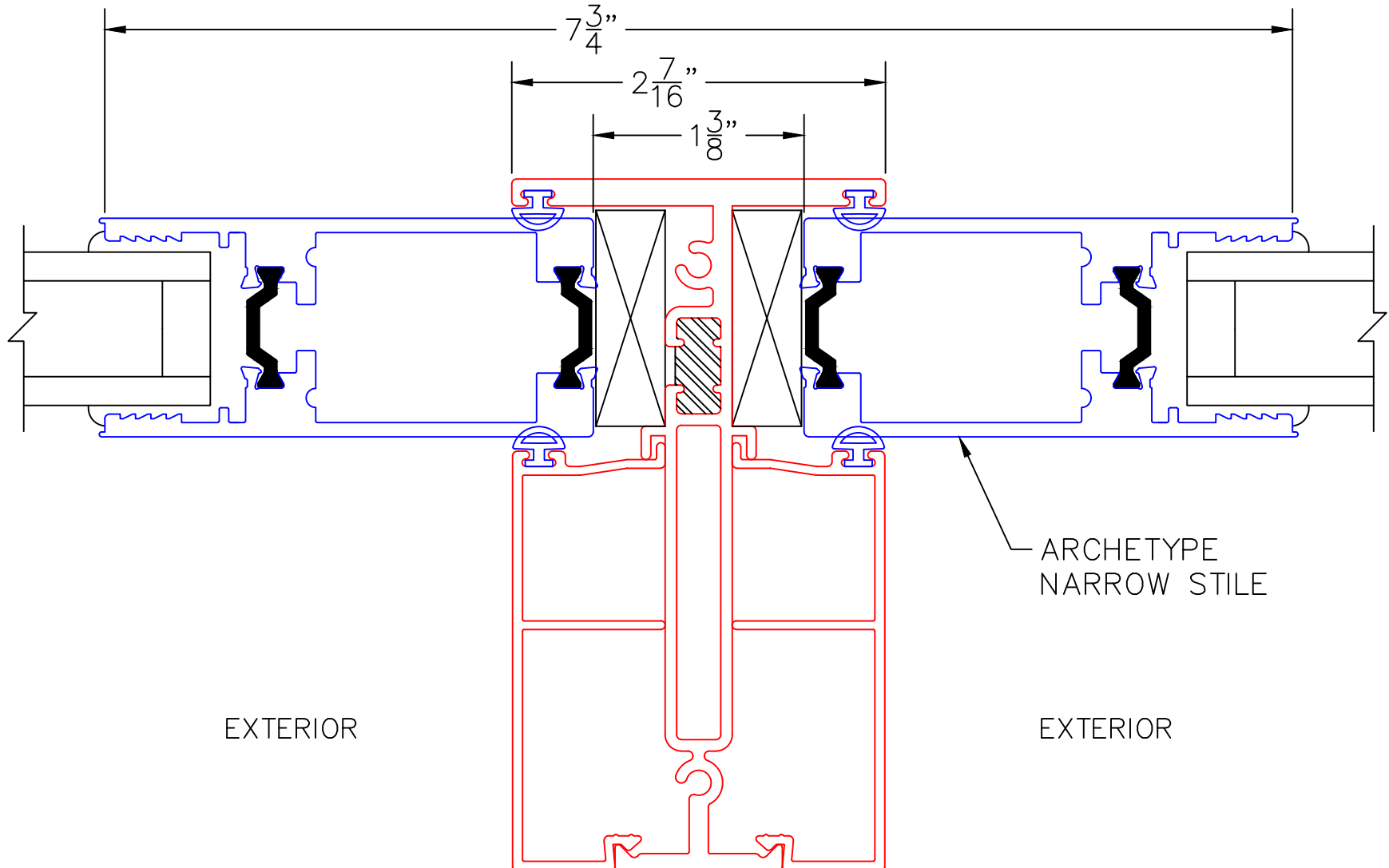

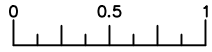

(USE RULER TO SCALE DIMENSIONS IN INCHES)

**SCALE: FULL**

DOOR PANEL INSERT DETAILS  
1" GLAZING SHOWN





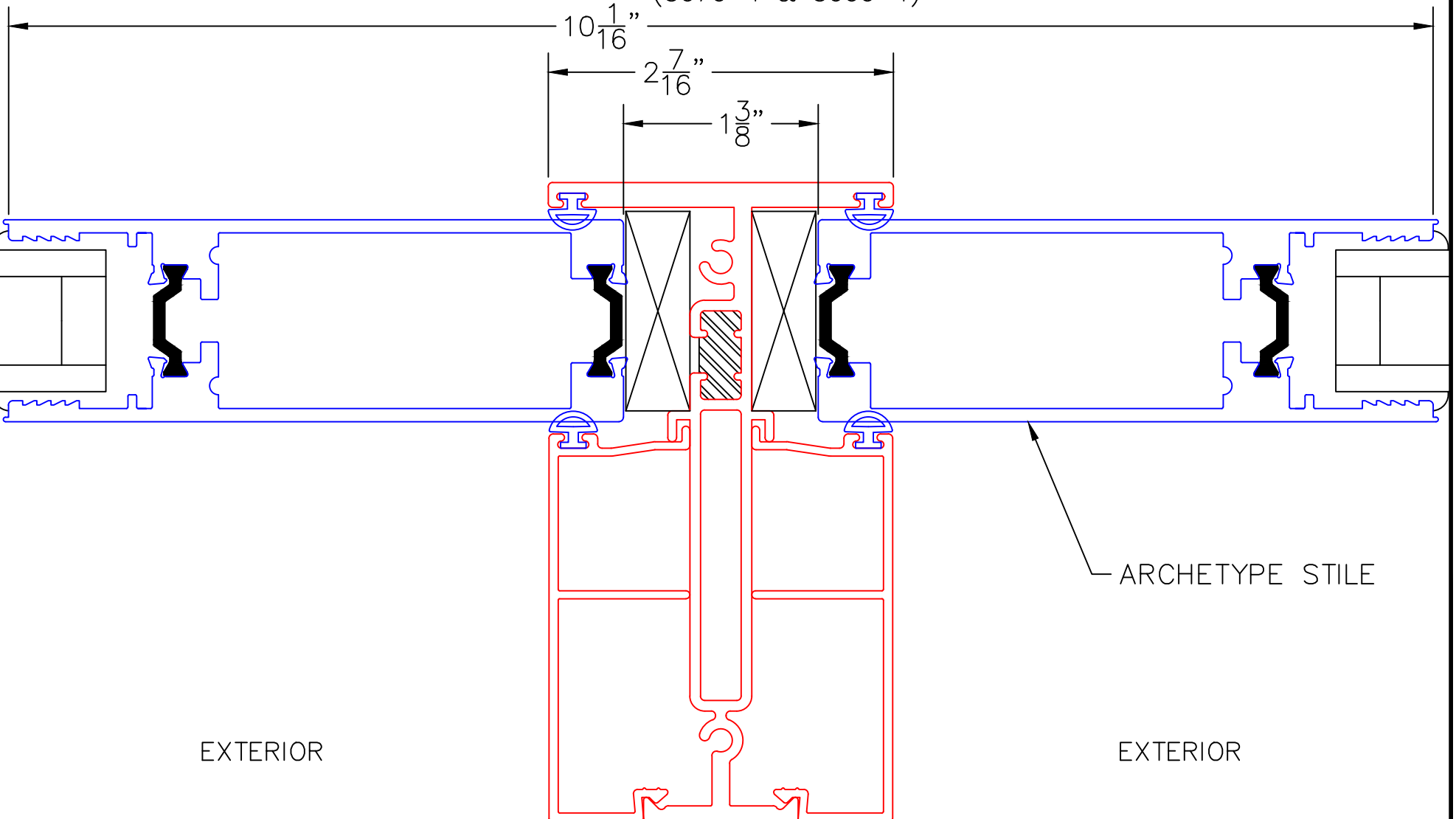

























4B

VERTICAL TDL  
W/ARCHETYPE STILE INSERT  
(3070-T & 3000-T)



[Architecturals  
Click Here](#)

[Product Specs  
Click Here](#)

BILL OF MATERIALS			
ITEM#	PART#	DESCRIPTION	IMAGE
ALUMINUM EXTRUSIONS			
1	3801	1" GLAZING BEAD	
2	<del>3802</del>	<del>1" BENDABLE GLAZING BEAD</del>	<del></del>
3	<del>3803</del>	<del>1/4" GLAZING BEAD</del>	<del></del>
4	3804	9/16" GLAZING BEAD	
5	3805	4.5 FRAME	
6	3806	TDL	
7	3807	1-1/2" SERIES GLASS STOP	
8	3810	2-1/4" SERIES GLASS STOP	
9	3811	1 1/4" GLASS STOP	
10	3812	INTERSECTING MULLION KEY (INTERSECTING TDL)	
11	3814	APPLIED GRID INTERIOR	
12	3815	SHEAR BLOCK (FOR HP ONLY)	
13	FW1194	2.0" x 0.25" ALUMINUM BAR (INTERSECTING TDL HP ONLY)	
14	FW1195	1.5" x 0.25" ALUMINUM BAR (INTERSECTING TDL HP ONLY)	
15		SILL PAN, BLOCK FRAME	
16		SILL PAN, NAIL ON	
17	3082	THERMAL MULLION	
18	3809	4.5 BLOCK FRAME	
19	<del>3816</del>	<del>1 1/4" TIERED GLASS STOP</del>	<del></del>
20	3817	90° CORNER BUTT GLAZED EXTERIOR CAP/COVER FOR 1.25" GLASS	
21	3818	90° CORNER BUTT GLAZED INTERIOR CAP/COVER FOR 1.25" GLASS	
HARDWARE			
31	VARY BY COLOR	SCREW NO 10, PPH, 1.00"	
32	VARY BY COLOR	SCREW NO 6, PFHU, .50"	
33	VARY BY COLOR	SCREW NO 8, PFH, 1 1/2"	
SEAL & SEALANT			
51	25199	BULB VINYL - MINI (ASTM C864)	
52	25031	BULB VINYL - LARGE (ASTM C864)	
53	19120	Q-LON WEATHERSTRIP (U 5212)	
54	18622	SETTING BLOCK 3/8 X 1 X 4	
55	18621	SETTING BLOCK 1/8 X 1 X 4	
56	23217	RIGID PVC SETTING BLOCK	
57	FW1237	1.5" SEAM CAP (USE WITH 25918)	