

[Product Specifications](#)
[Click Here](#)

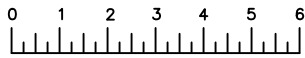

(USE RULER TO SCALE DIMENSIONS IN INCHES)
SCALE: 1/4

WINDOW INSERTS

1
HORIZONTAL
TDL

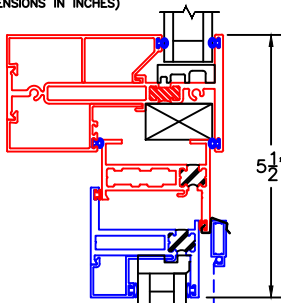

EXTERIOR

3
HORIZONTAL
TDL

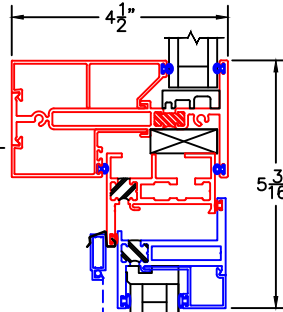

EXTERIOR

5
HORIZONTAL
TDL

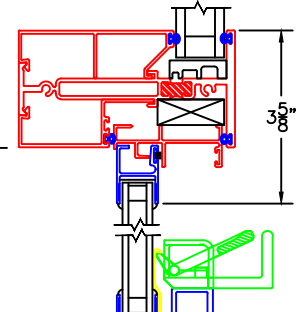

EXTERIOR

2
BLOCK SILL
W/ SILL PAN

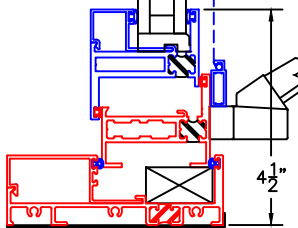

3800-T 1" GLAZING OVER
250-T 1" GLAZING
CASEMENT/AWNING

4
BLOCK SILL
W/ SILL PAN

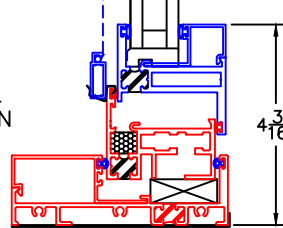

3800-T 1" GLAZING OVER
250-T 1" GLAZING
HOPPER

6
BLOCK SILL
W/ SILL PAN

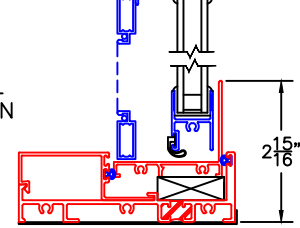

3800-T 1" GLAZING OVER
250 5/8" GLAZING
SINGLE HUNG

7
HORIZONTAL
TDL

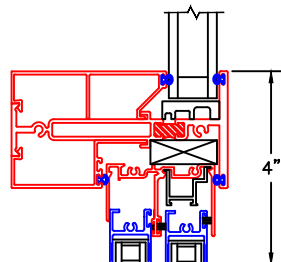

EXTERIOR

9
BLOCK
JAMB

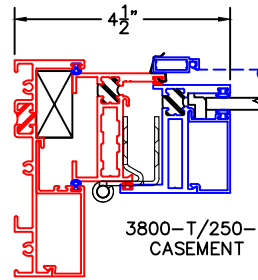

3800-T/250-T
CASEMENT
EXTERIOR

11
BLOCK
JAMB

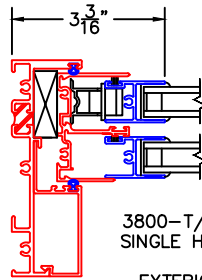

3800-T/250
SINGLE HUNG
EXTERIOR

8
BLOCK SILL
W/ SILL PAN

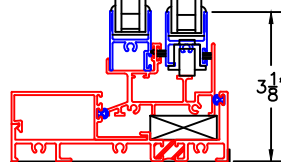

3800-T 1" GLAZING OVER
250 5/8" GLAZING
XO SLIDER

10
BLOCK
JAMB

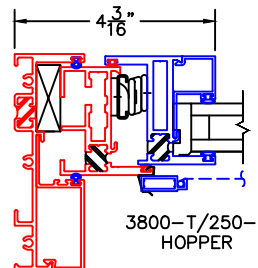

3800-T/250-T
HOPPER
EXTERIOR

12
BLOCK
JAMB

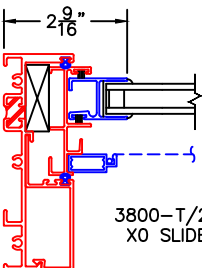

3800-T/250
XO SLIDER
EXTERIOR

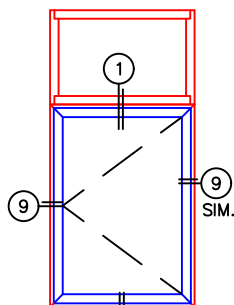

O/C WINDOW

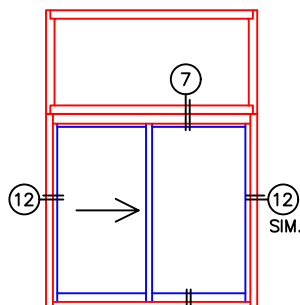

O/XO WINDOW

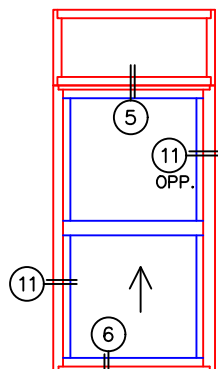

O/SH WINDOW

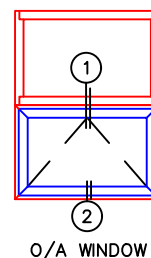

O/A WINDOW

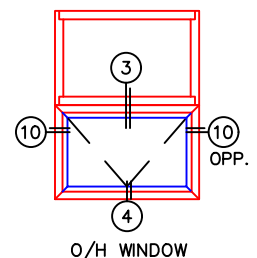

O/H WINDOW

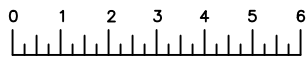

(USE RULER TO SCALE DIMENSIONS IN INCHES)
SCALE: 1/4

[Architecturals Click Here](#) | [Parts List Click Here](#)

WINDOW INSERTS

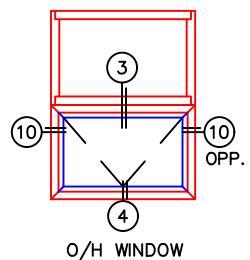
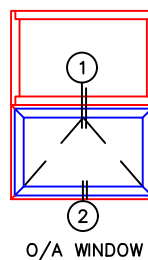
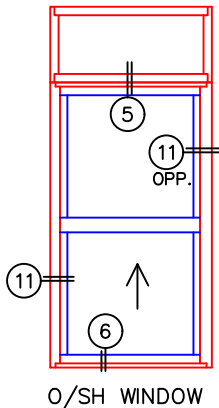
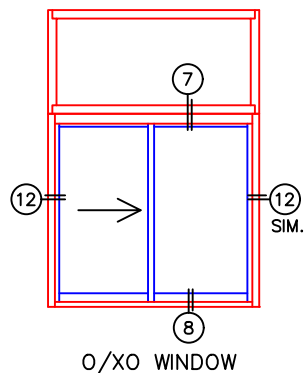
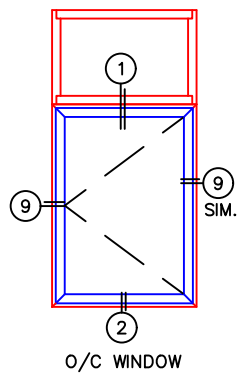
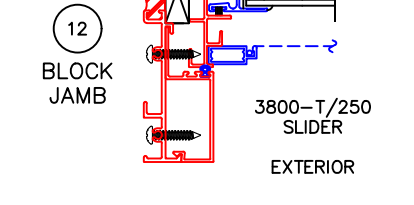
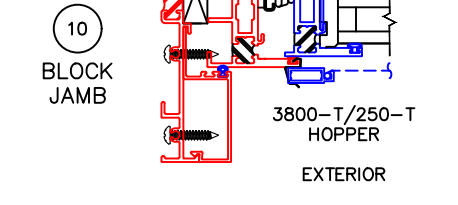
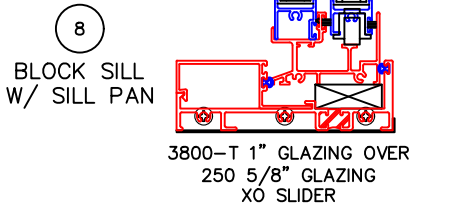
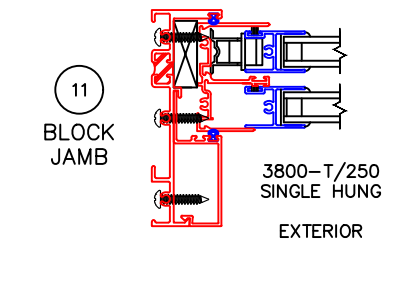
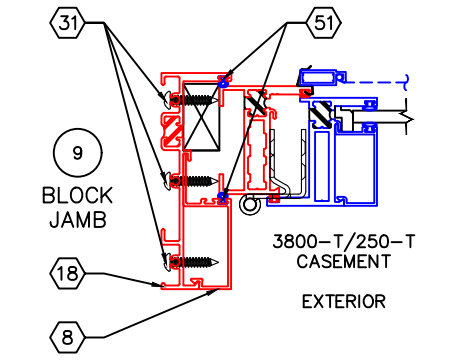
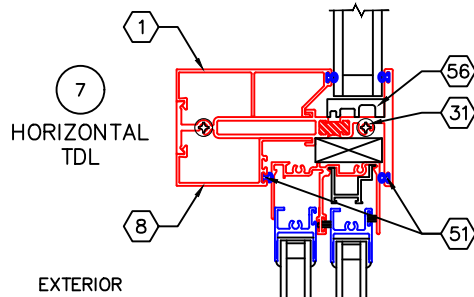
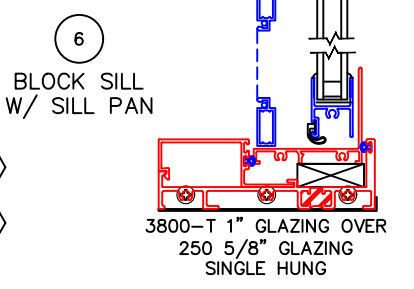
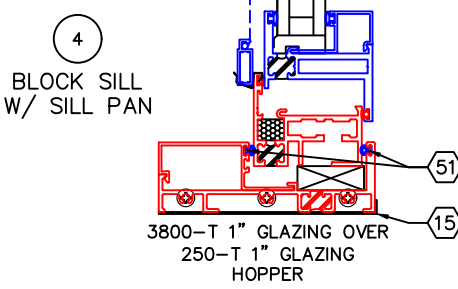
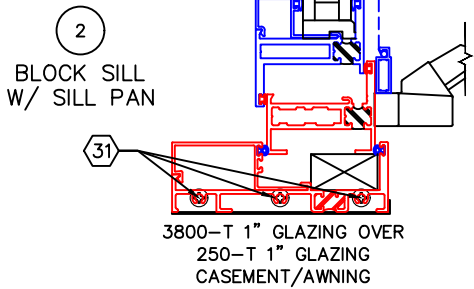
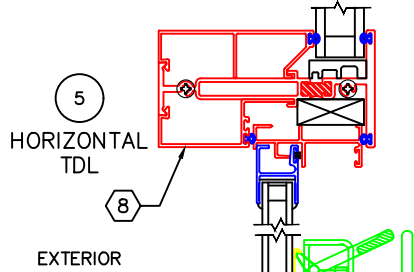
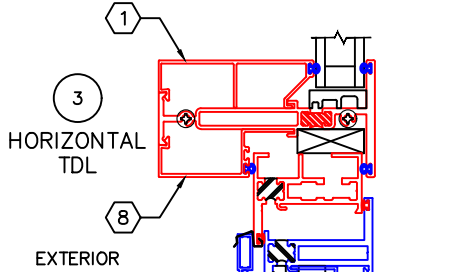
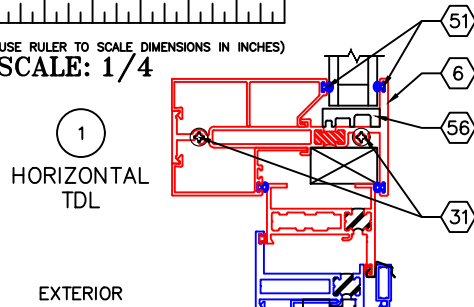

0 0.5 1
(USE RULER TO SCALE DIMENSIONS IN INCHES)
SCALE: FULL

WINDOW INSERT DETAILS
1" INSULATED GLAZING

①
HORIZONTAL
TDL

EXTERIOR

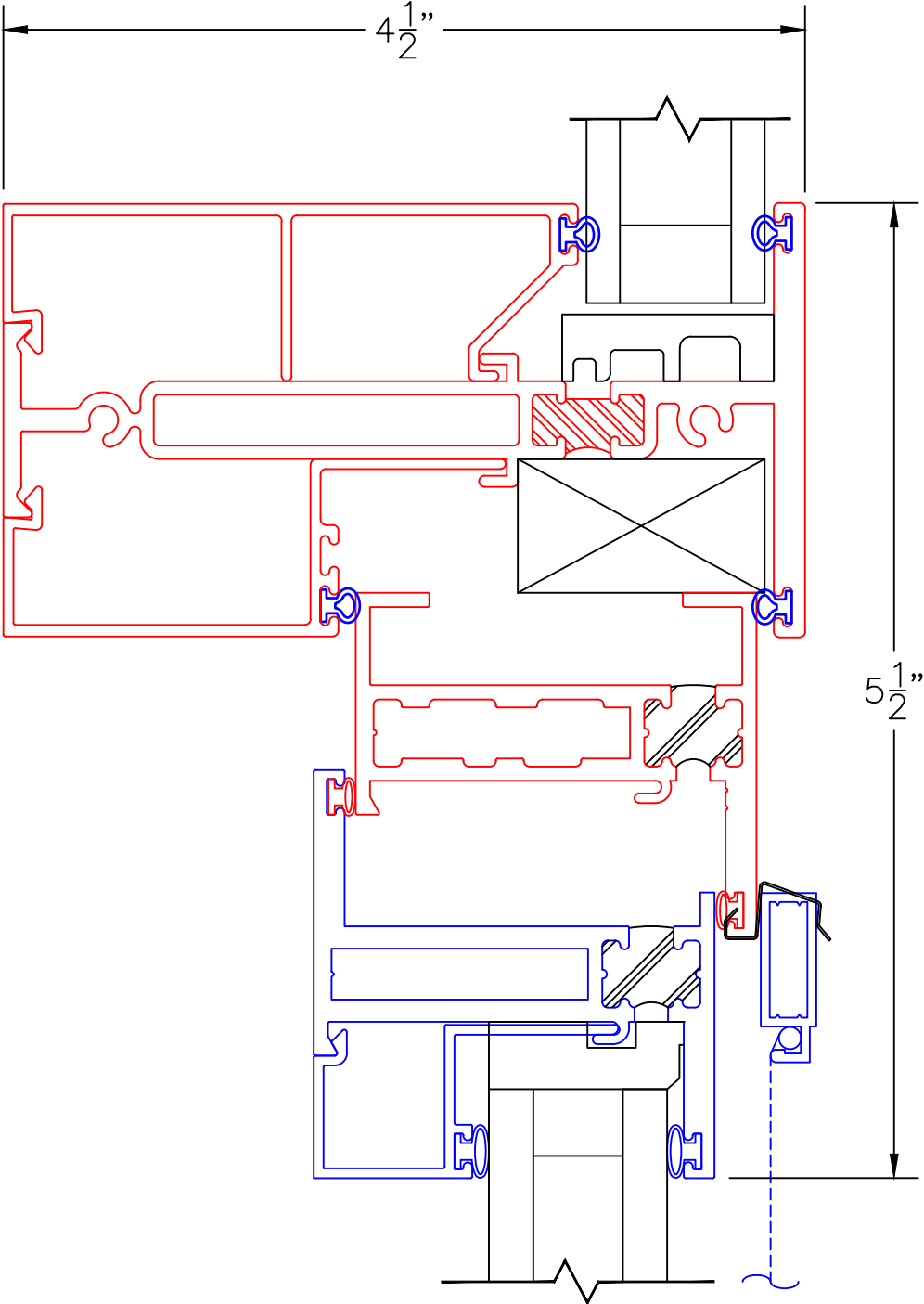

3800-T 1" GLAZING OVER
250-T CASEMENT INSERT

0 0.5 1
(USE RULER TO SCALE DIMENSIONS IN INCHES)
SCALE: FULL

WINDOW INSERT DETAILS
1" INSULATED GLAZING

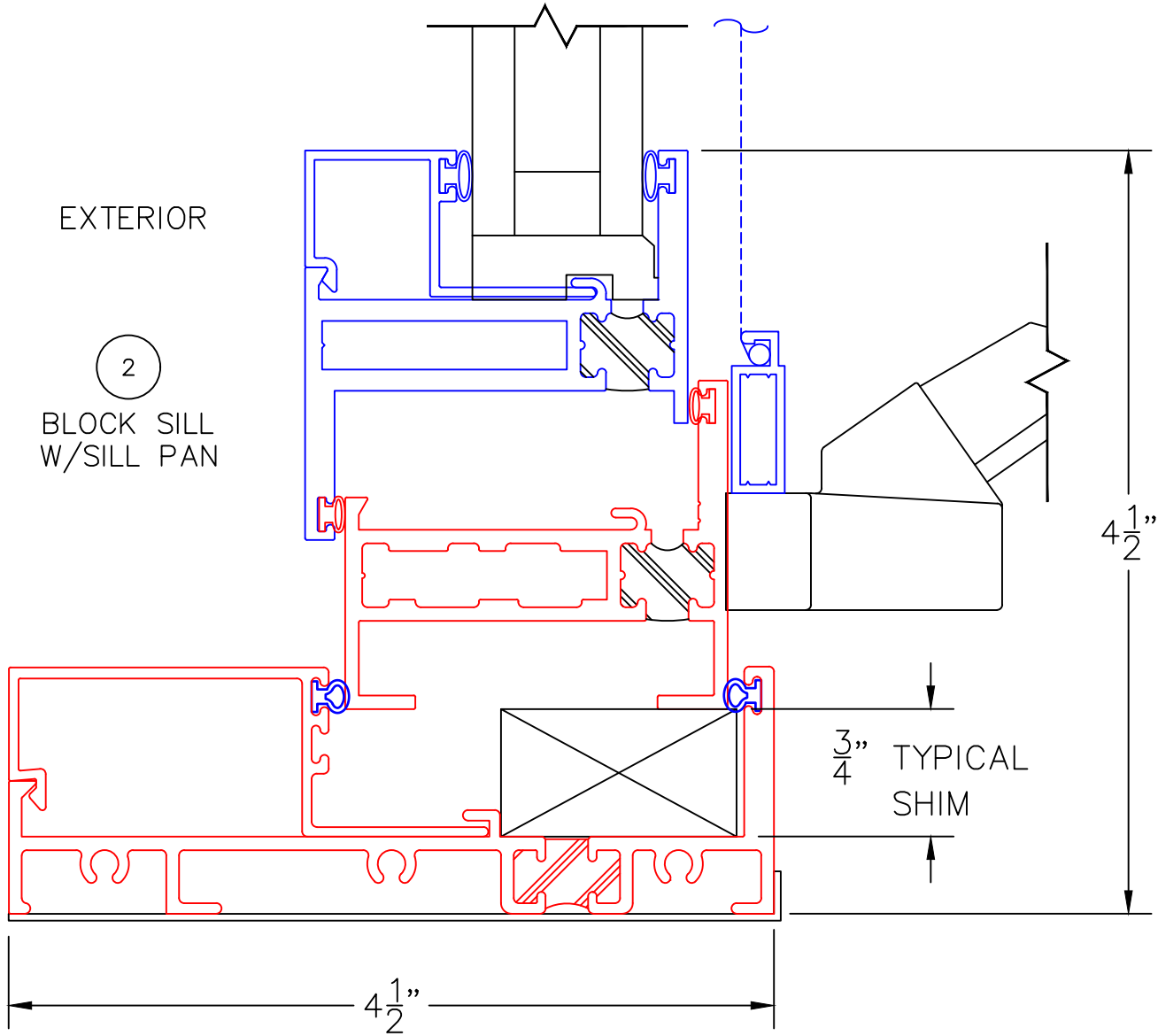

3800-T SILL WITH
250-T CASEMENT/AWNING INSERT

0 0.5 1
(USE RULER TO SCALE DIMENSIONS IN INCHES)
SCALE: FULL

WINDOW INSERT DETAILS
1" INSULATED GLAZING

3
HORIZONTAL
TDL

EXTERIOR

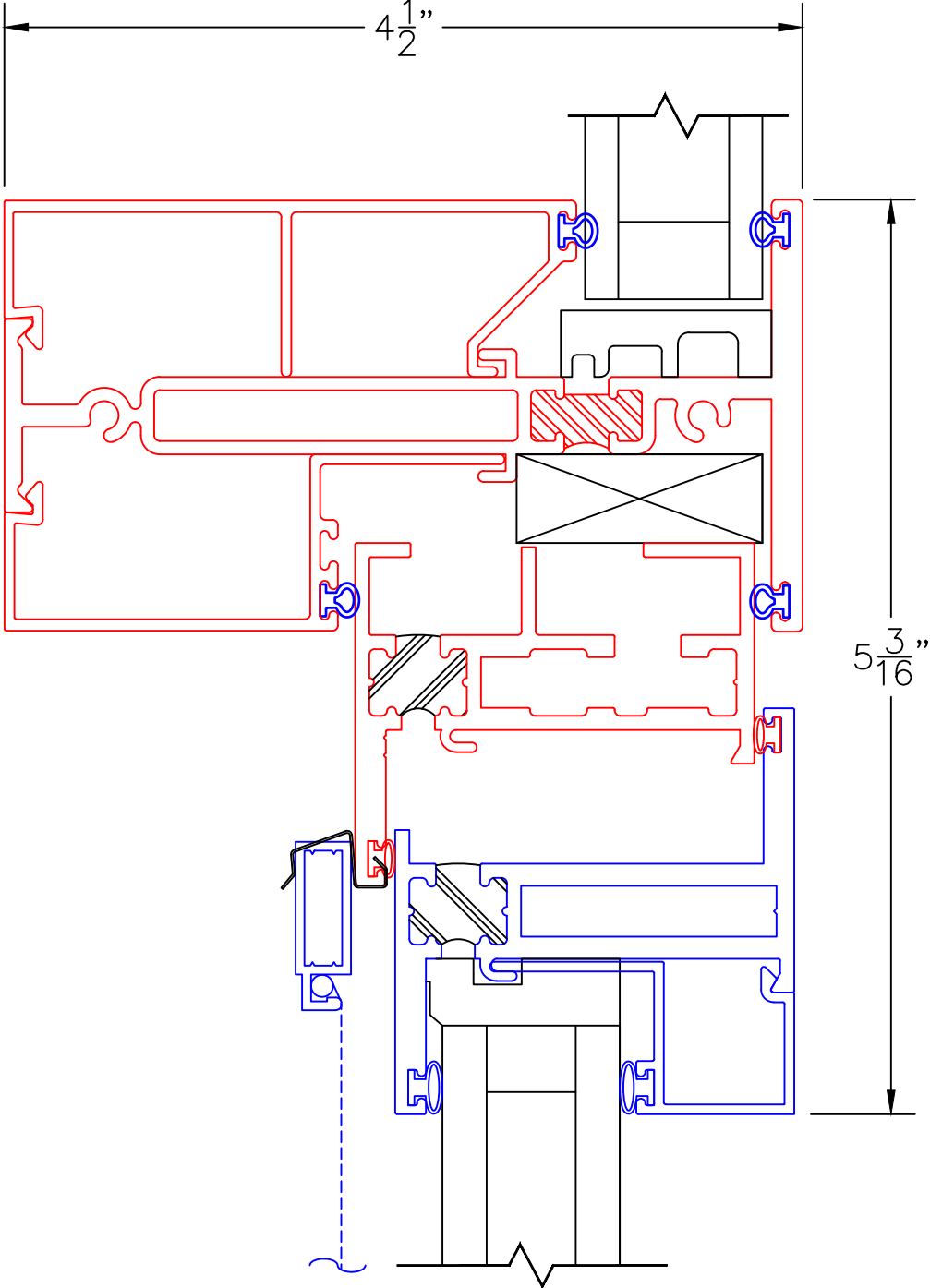

3800-T 1" GLAZING OVER
250-T HOPPER INSERT

0 0.5 1
(USE RULER TO SCALE DIMENSIONS IN INCHES)
SCALE: FULL

WINDOW INSERT DETAILS
1" INSULATED GLAZING

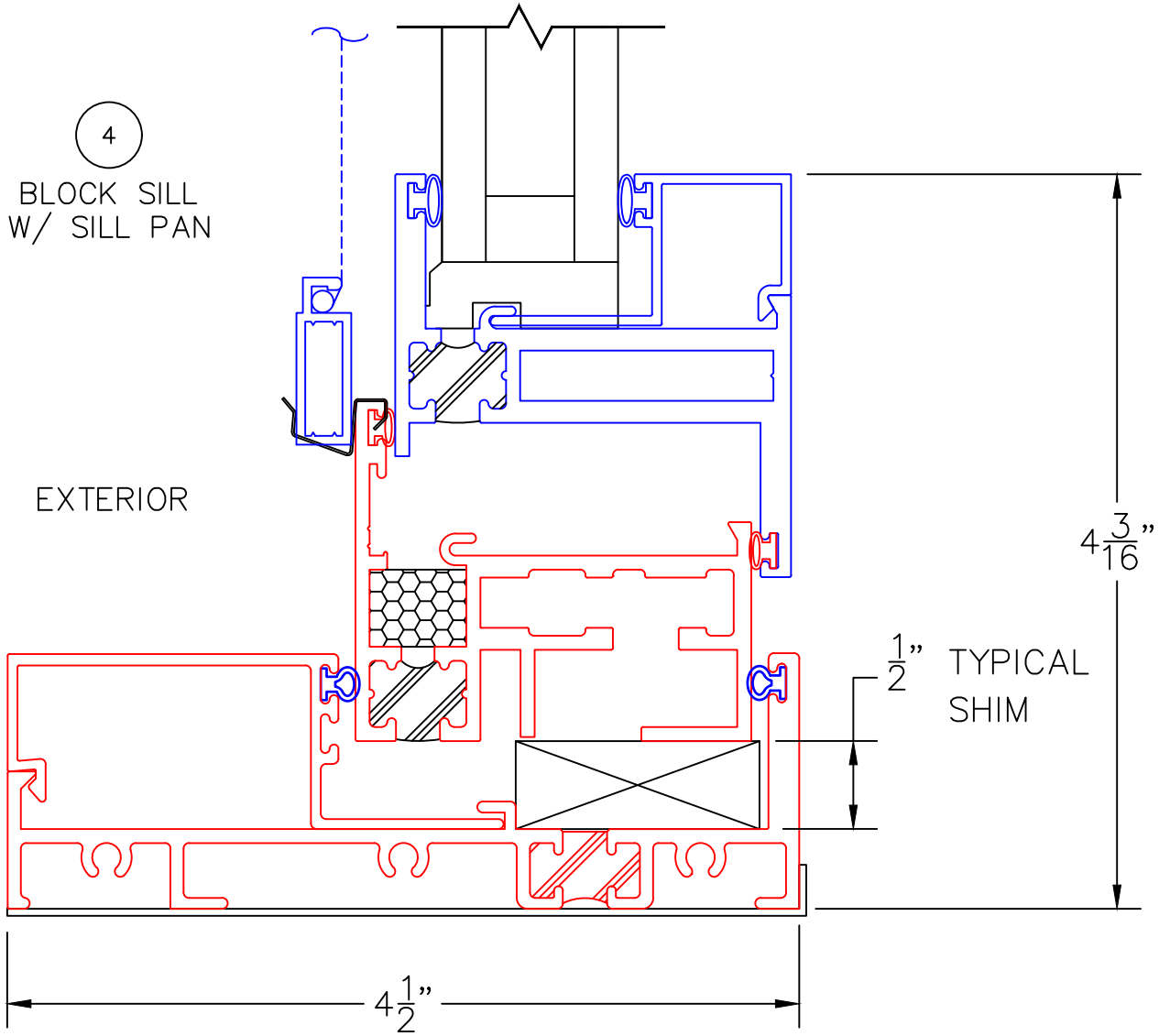

3800-T SILL WITH
250-T HOPPER INSERT

0 0.5 1
(USE RULER TO SCALE DIMENSIONS IN INCHES)
SCALE: FULL

WINDOW INSERT DETAILS
GLAZING AS NOTED

5
HORIZONTAL
TDL

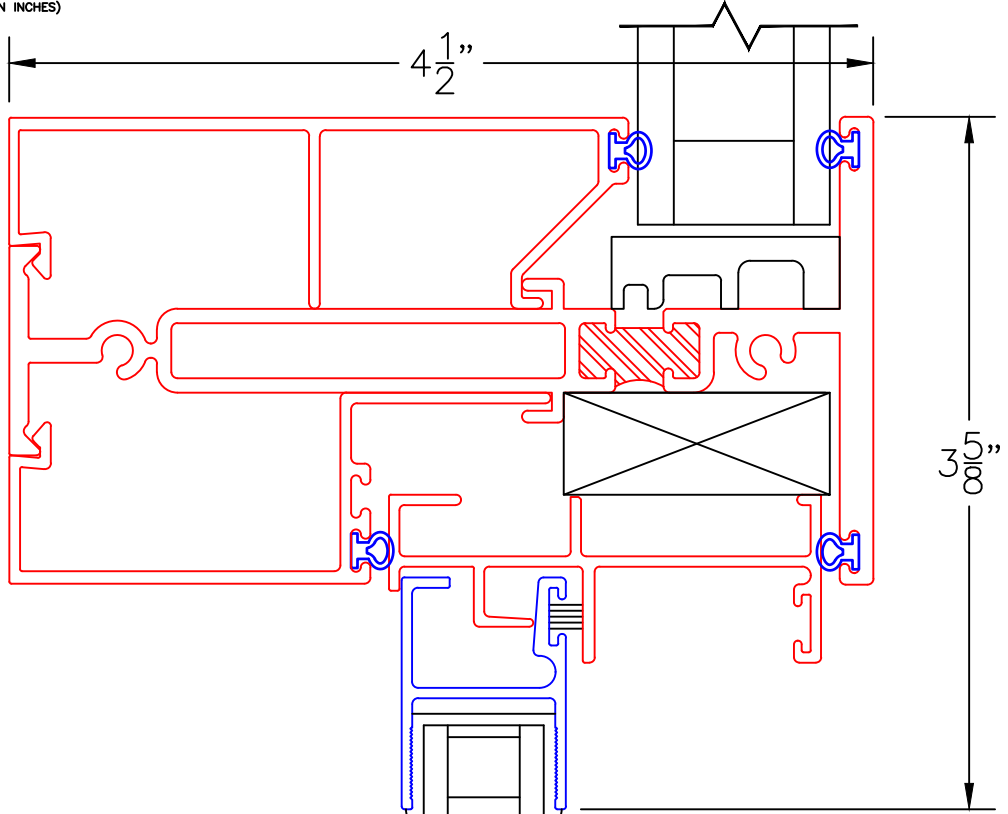

EXTERIOR

3800-T 1" GLAZING OVER
250 5\8" GLAZING
SINGLE HUNG INSERT

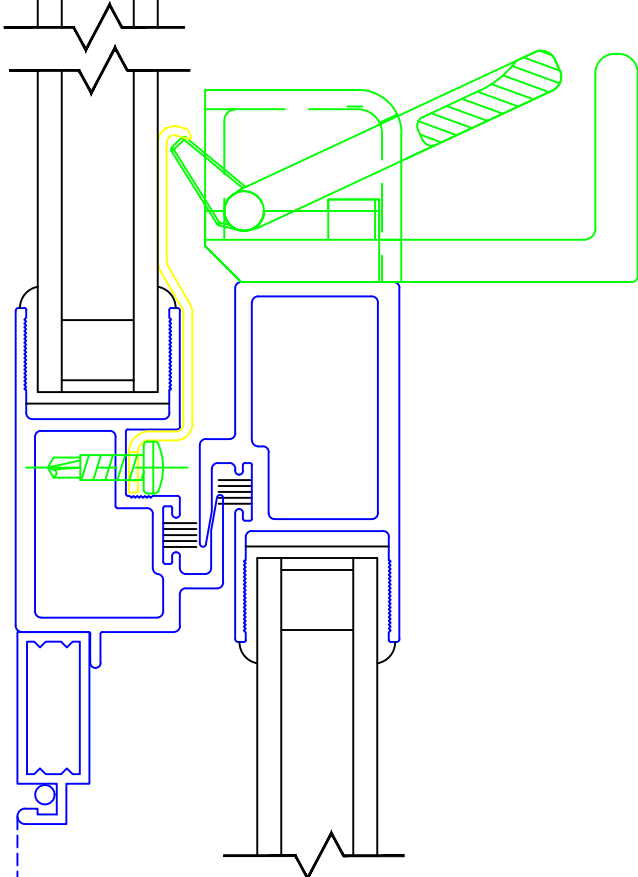

0 0.5 1
(USE RULER TO SCALE DIMENSIONS IN INCHES)
SCALE: FULL

WINDOW INSERT DETAILS
5/8" INSULATED GLAZING

EXTERIOR

6
BLOCK SILL
W/ SILL PAN

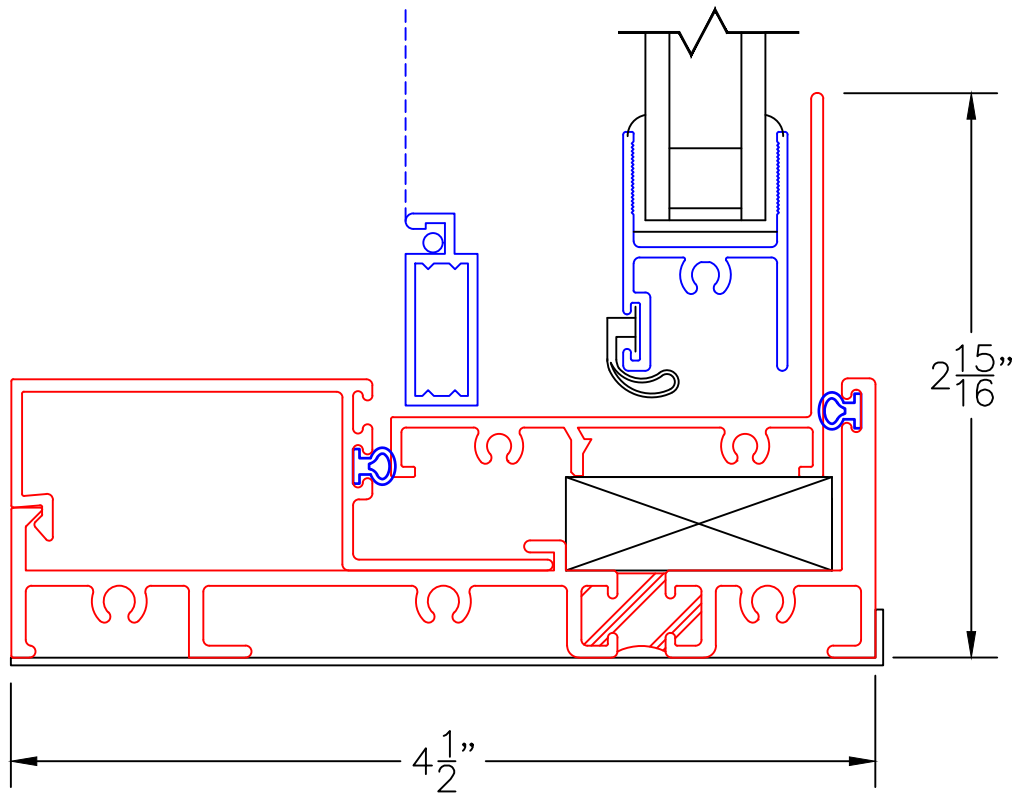

3800-T SILL WITH
250 SINGLE HUNG INSERT

0 0.5 1
(USE RULER TO SCALE DIMENSIONS IN INCHES)
SCALE: FULL

WINDOW INSERT DETAILS
GLAZING AS NOTED

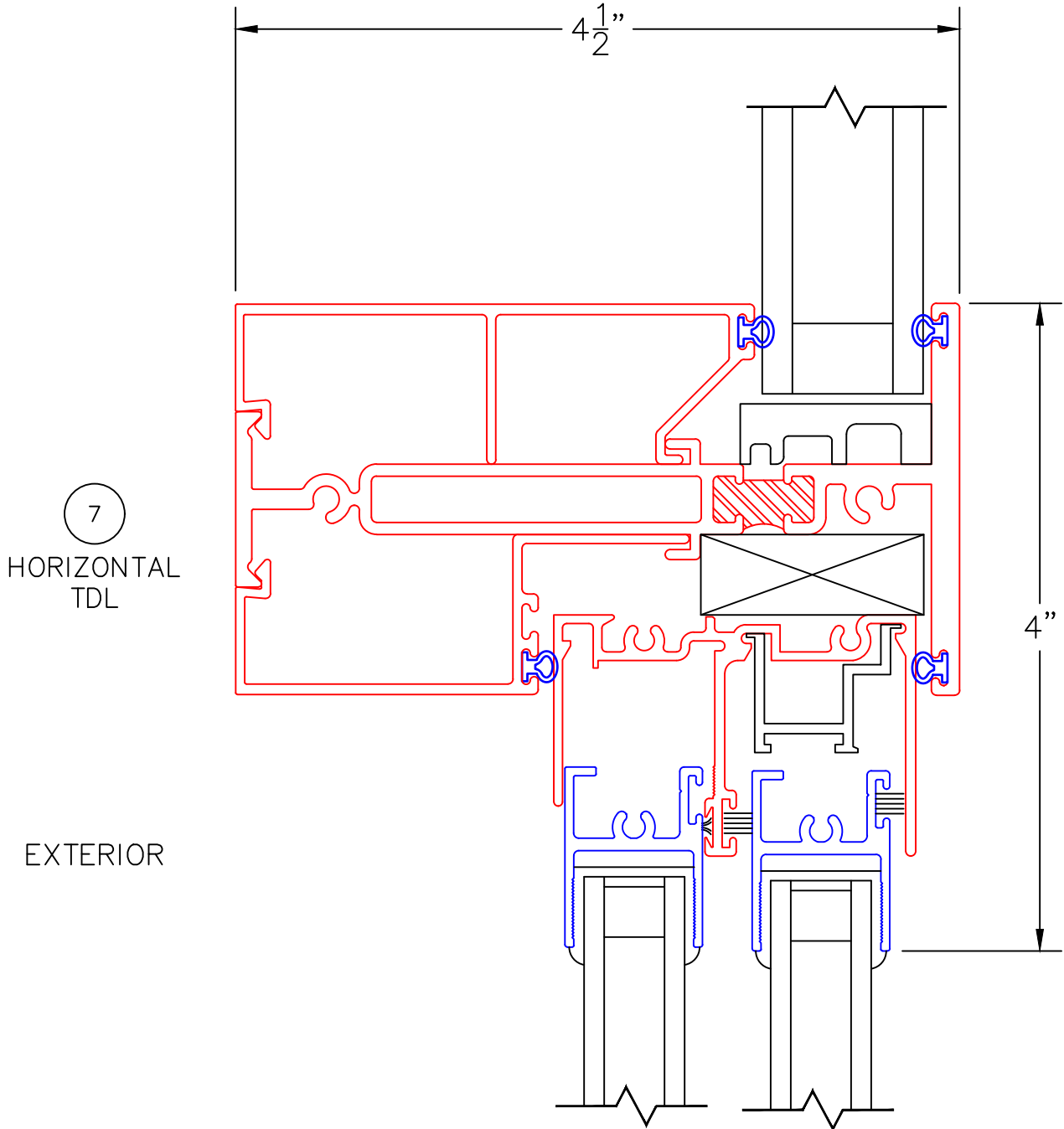

3800-T 1" GLAZING OVER
250 5\8" GLAZING XO SLIDER INSERT

0 0.5 1
(USE RULER TO SCALE DIMENSIONS IN INCHES)
SCALE: FULL

WINDOW INSERT DETAILS
5/8" INSULATED GLAZING

EXTERIOR

8
BLOCK SILL
W/ SILL PAN

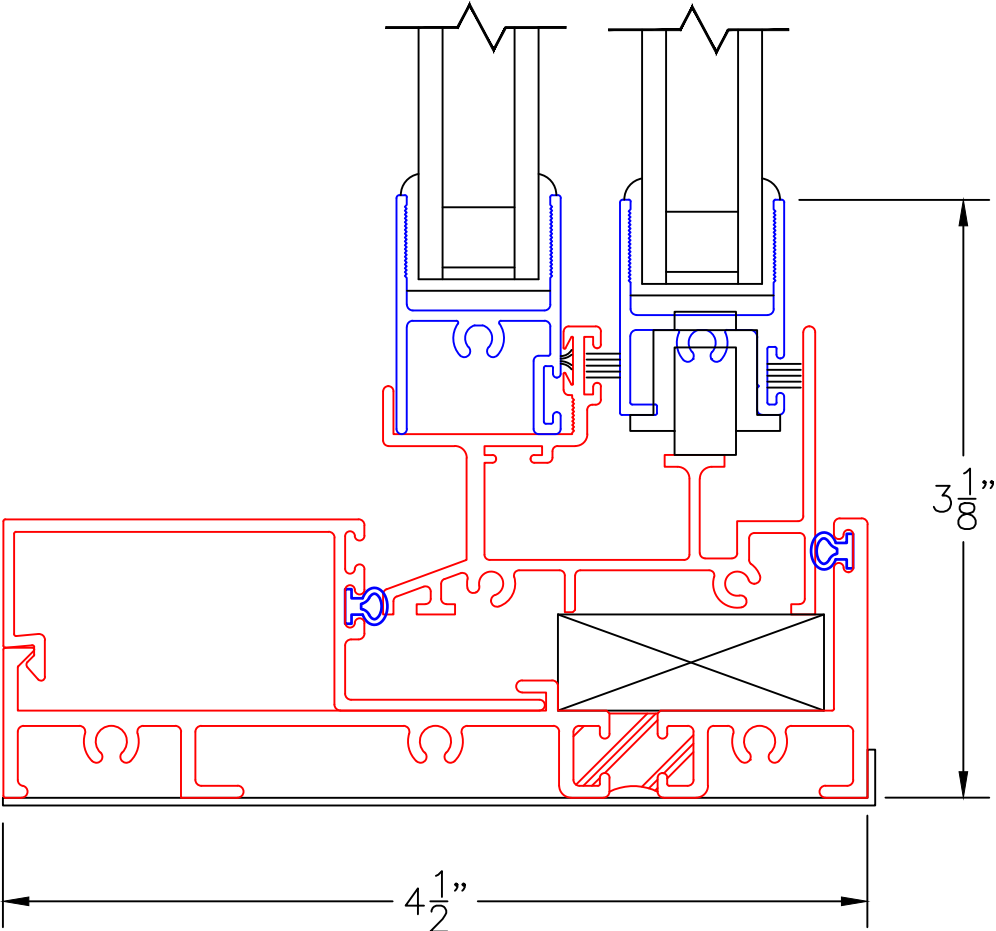

3800-T SILL WITH
250 XO SLIDER INSERT

0 0.5 1
(USE RULER TO SCALE DIMENSIONS IN INCHES)
SCALE: FULL

WINDOW INSERT DETAILS
1/4" SINGLE GLAZING

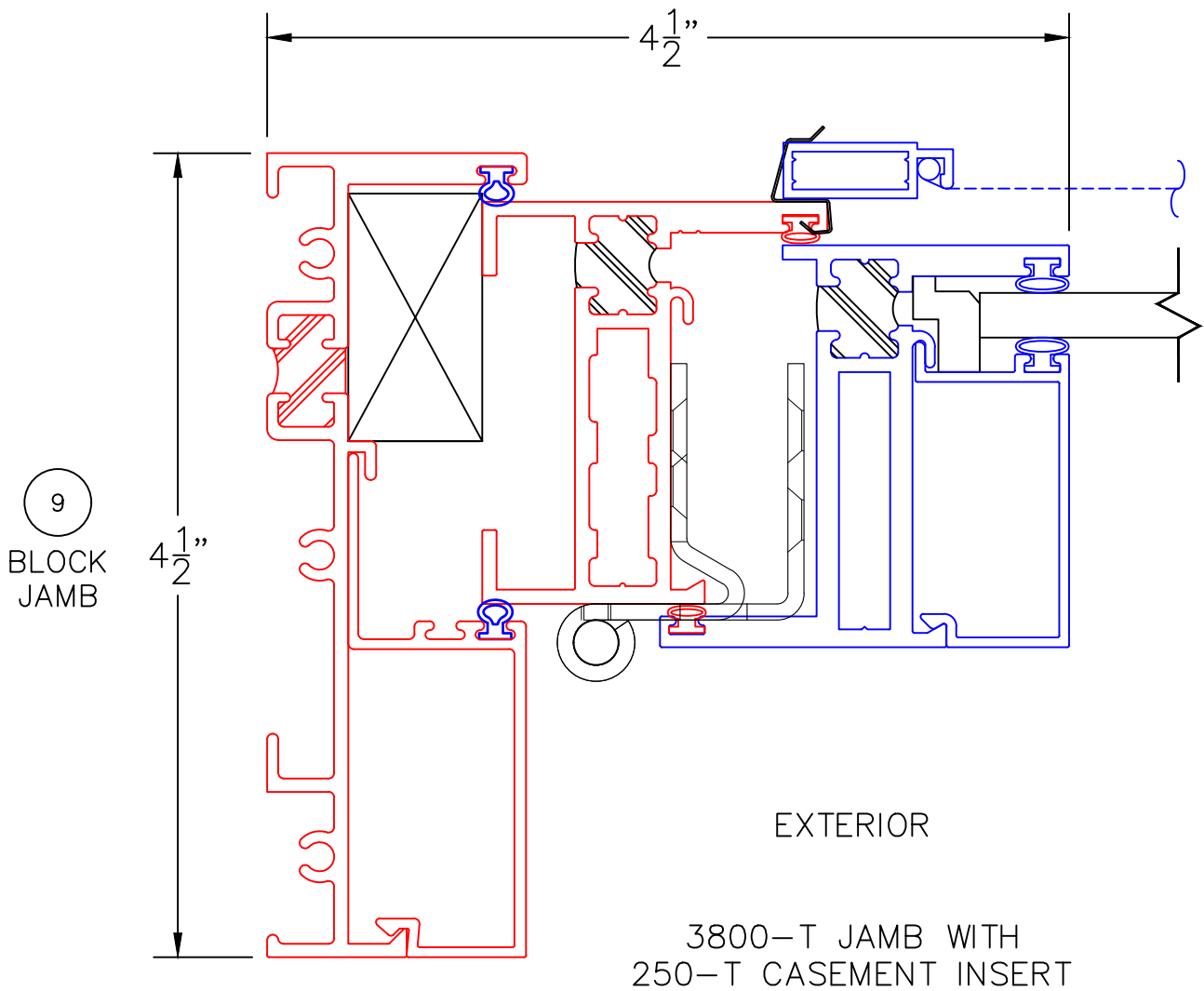

0 0.5 1
(USE RULER TO SCALE DIMENSIONS IN INCHES)
SCALE: FULL

WINDOW INSERT DETAILS
1" INSULATED GLAZING

10
BLOCK
JAMB

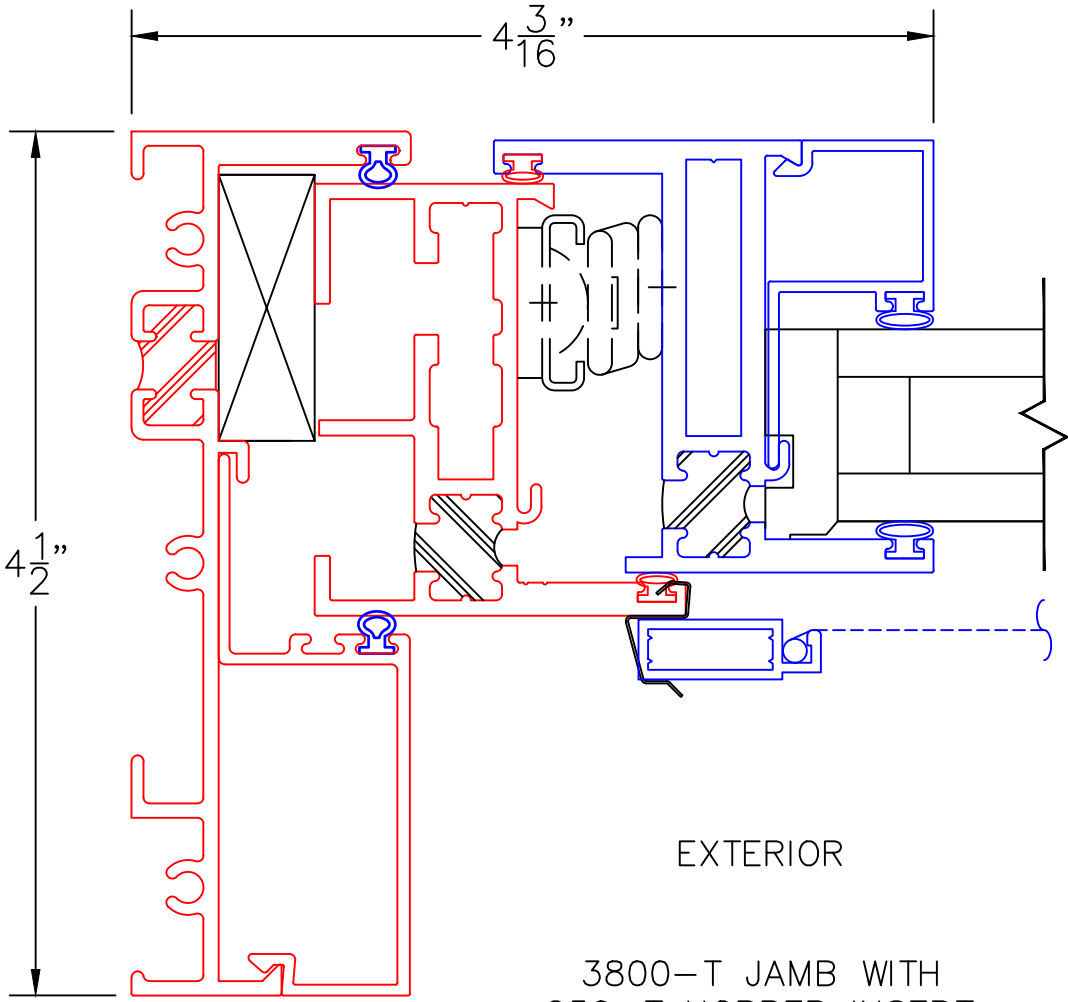

3800-T JAMB WITH
250-T HOPPER INSERT

0 0.5 1
(USE RULER TO SCALE DIMENSIONS IN INCHES)
SCALE: FULL

WINDOW INSERT DETAILS
5/8" INSULATED GLAZING

11
BLOCK
JAMB

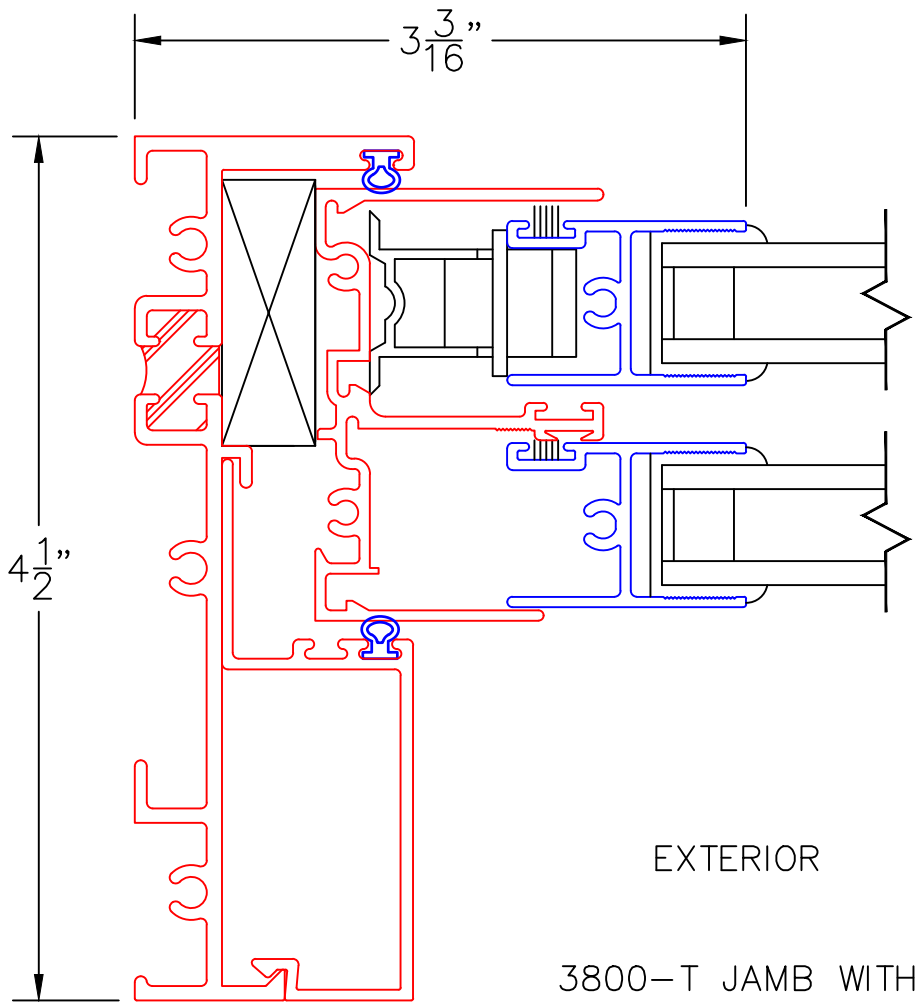

3800-T JAMB WITH
250 SINGLE HUNG INSERT

0 0.5 1
(USE RULER TO SCALE DIMENSIONS IN INCHES)
SCALE: FULL





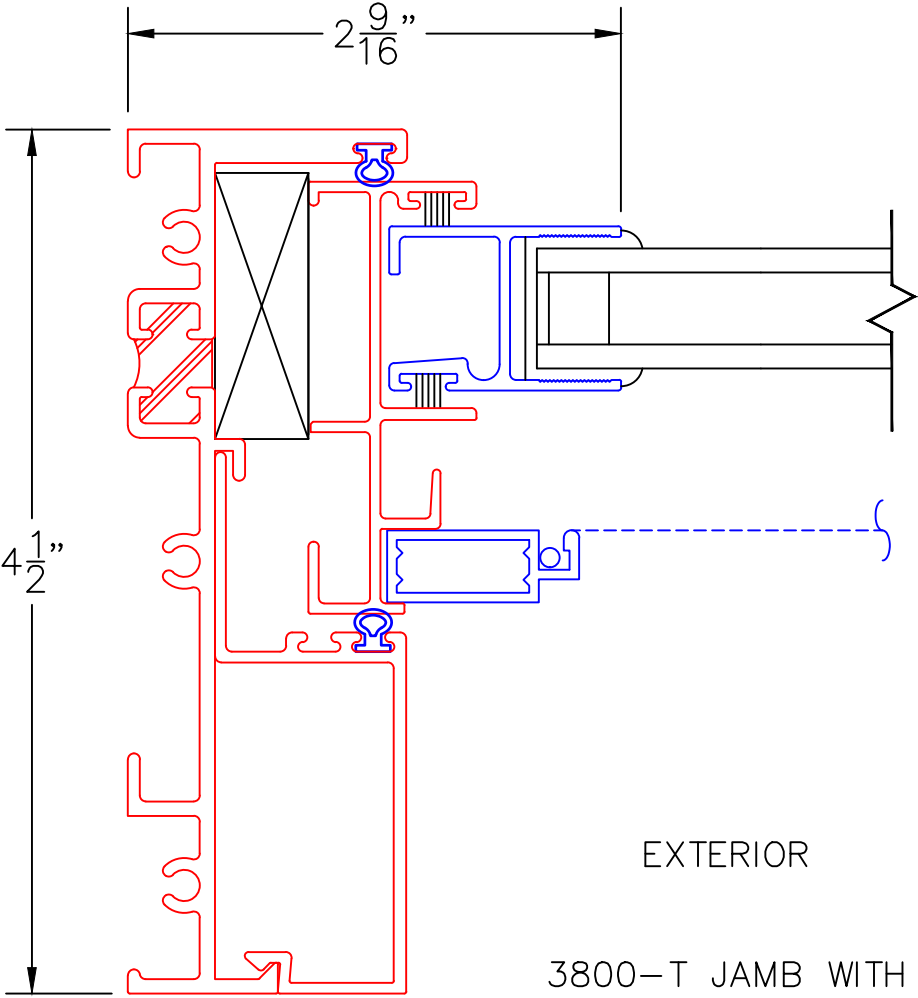























WINDOW INSERT DETAILS
5/8" INSULATED GLAZING

12
BLOCK
JAMB



3800-T JAMB WITH
250 XO SLIDER INSERT

[Architecturals Click Here](#) [Product Specs Click Here](#)

BILL OF MATERIALS			
ITEM #	PART#	DESCRIPTION	IMAGE
ALUMINUM EXTRUSIONS			
1	3801	1" GLAZING BEAD	
2	3802	1" BENDABLE GLAZING BEAD	
3	3803	1/4" GLAZING BEAD	
4	3804	9/16" GLAZING BEAD	
5	3805	4.5 FRAME	
6	3806	TDL	
7	3807	1-1/2" SERIES GLASS STOP	
8	3810	2-1/4" SERIES GLASS STOP	
9	3811	1 1/4" GLASS STOP	
10	3812	INTERSECTING MULLION KEY (INTERSECTING TDL)	
11	3814	APPLIED GRID INTERIOR	
12	3815	SHEAR BLOCK (FOR HP ONLY)	
13	FW1194	2.0" x 0.25" ALUMINUM BAR (INTERSECTING TDL HP ONLY)	
14	FW1195	1.5" x 0.25" ALUMINUM BAR (INTERSECTING TDL HP ONLY)	
15		SILL PAN, BLOCK FRAME	
16		SILL PAN, NAIL ON	
17	3082	THERMAL MULLION	
18	3809	4.5 BLOCK FRAME	
19	3816	1 1/4" TIERED GLASS STOP	
20	3817	90° CORNER BUTT GLAZED EXTERIOR CAP/COVER FOR 1.25" GLASS	
21	3818	90° CORNER BUTT GLAZED INTERIOR CAP/COVER FOR 1.25" GLASS	
HARDWARE			
31	VARY BY COLOR	SCREW NO 10, PPH, 1.00"	
32	VARY BY COLOR	SCREW NO 6, PFHU, .50"	
33	VARY BY COLOR	SCREW NO 8, PFH, 1 1/2"	
SEAL & SEALANT			
51	25199	BULB VINYL - MINI (ASTM C864)	
52	25031	BULB VINYL - LARGE (ASTM C864)	
53	19120	Q-LON WEATHERSTRIP (U 5212)	
54	18622	SETTING BLOCK 3/8 X 1 X 4	
55	18621	SETTING BLOCK 1/8 X 1 X 4	
56	23217	RIGID PVC SETTING BLOCK	