

[Product Specifications](#)
[Click Here](#)



(USE RULER TO SCALE DIMENSIONS IN INCHES)

SCALE: 1/4

JAMB MULLION DETAILS

1

EXTERNAL "1"
THERMALLY-BROKEN
JAMB MULLION

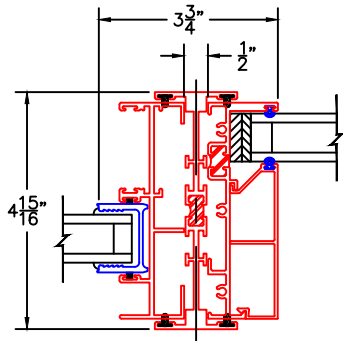

EXTERIOR

SERIES 1000 TO SERIES 3800-T

1A

EXTERNAL "1"
THERMALLY-BROKEN
JAMB MULLION

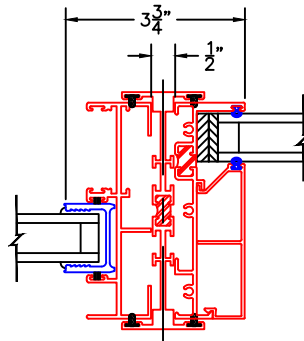

EXTERIOR

SERIES 3000 TO SERIES 3800-T

1B

EXTERNAL "1"
THERMALLY-BROKEN
JAMB MULLION

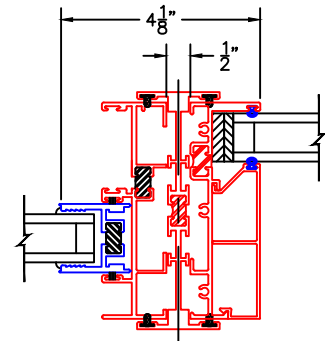

EXTERIOR

SERIES 3300-T TO SERIES 3800-T

2

EXTERNAL "1"
THERMALLY-BROKEN
JAMB MULLION

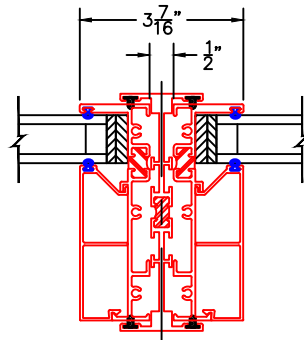

EXTERIOR

SERIES 3800-T TO SERIES 3800-T

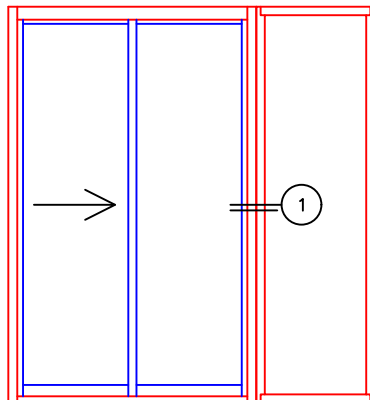

XO SLIDING DOOR MULLED TO 3800-T

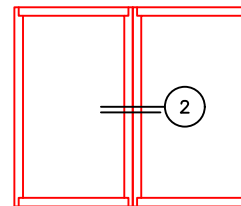

3800-T MULLED TO 3800-T

-EXTERIOR RATED PRODUCTS HAVE WEEP SLOTS ON HORIZONTAL SILLS.

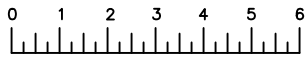

(USE RULER TO SCALE DIMENSIONS IN INCHES)

SCALE: 1/4

JAMB MULLION DETAILS

[Architecturals Click Here](#) [Parts List Click Here](#)

1

EXTERNAL "I"
THERMALLY-BROKEN
JAMB MULLION

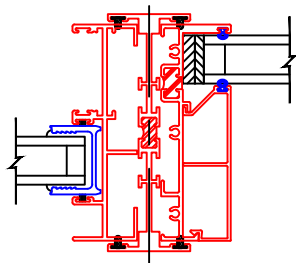

EXTERIOR

SERIES 1000 TO SERIES 3800-T

1A

EXTERNAL "I"
THERMALLY-BROKEN
JAMB MULLION

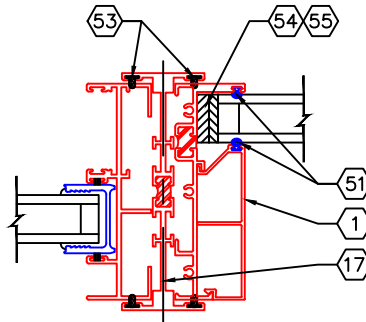

EXTERIOR

SERIES 3000 TO SERIES 3800-T

1B

EXTERNAL "I"
THERMALLY-BROKEN
JAMB MULLION

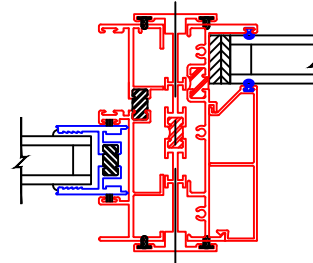

EXTERIOR

SERIES 3300-T TO SERIES 3800-T

2

EXTERNAL "I"
THERMALLY-BROKEN
JAMB MULLION

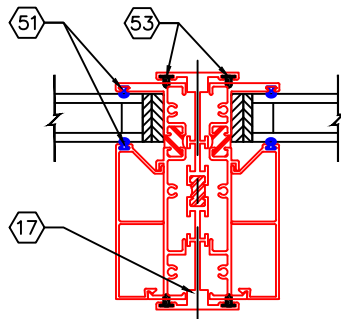

EXTERIOR

SERIES 3800-T TO SERIES 3800-T

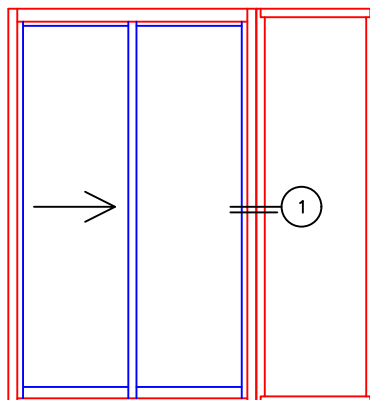

XO SLIDING DOOR MULLED TO 3800-T

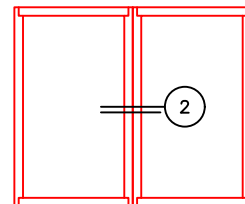

3800-T MULLED TO 3800-T

0 0.5 1
(USE RULER TO SCALE DIMENSIONS IN INCHES)
SCALE: FULL

THERMALLY-BROKEN
JAMB MULLION DETAILS
1" INSULATED GLAZING

1

JAMB MULLION

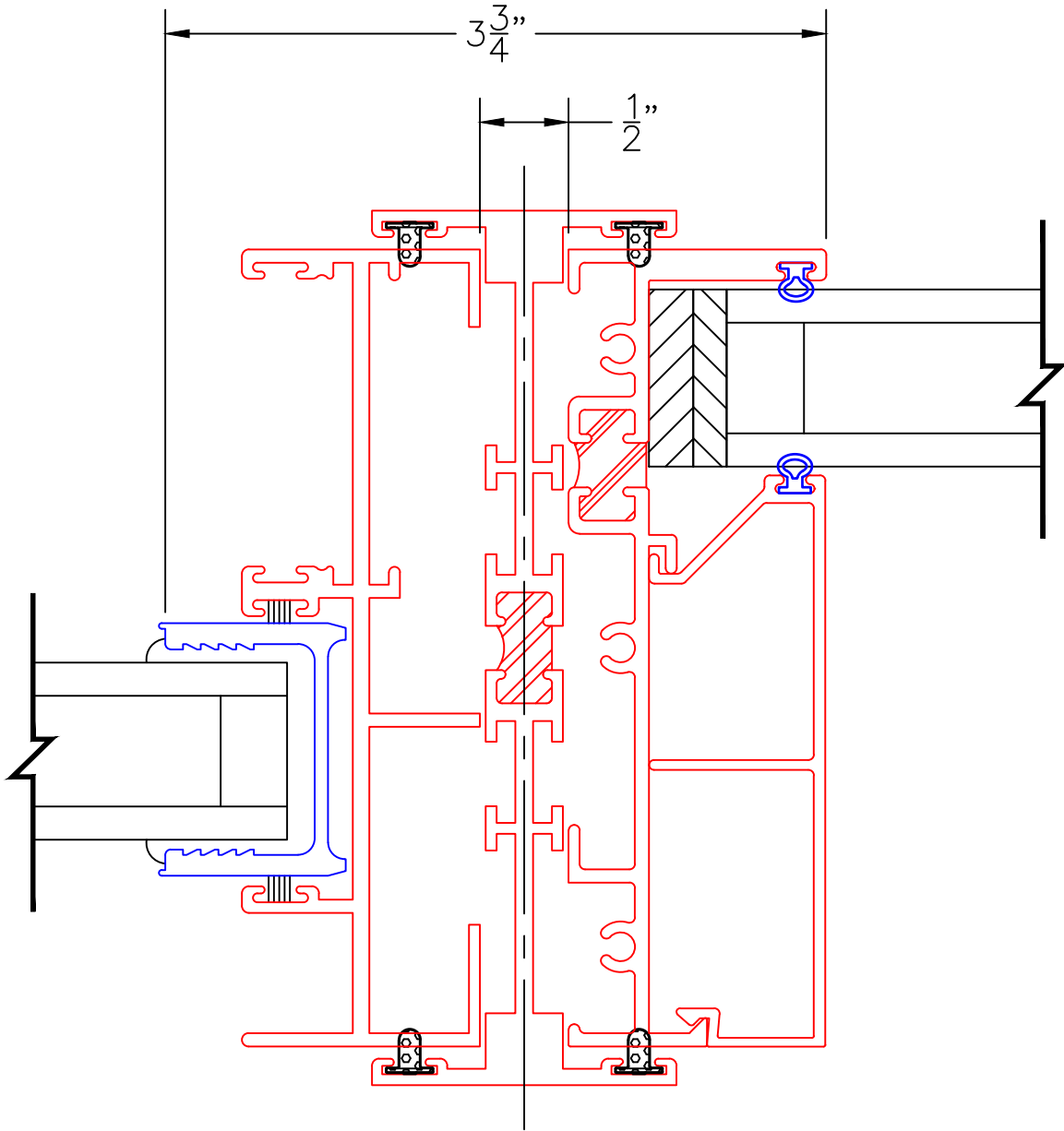

EXTERIOR

SERIES 1000 TO SERIES 3800-T

0 0.5 1
(USE RULER TO SCALE DIMENSIONS IN INCHES)
SCALE: FULL

THERMALLY-BROKEN JAMB MULLION DETAILS 1" INSULATED GLAZING

1A

JAMB MULLION

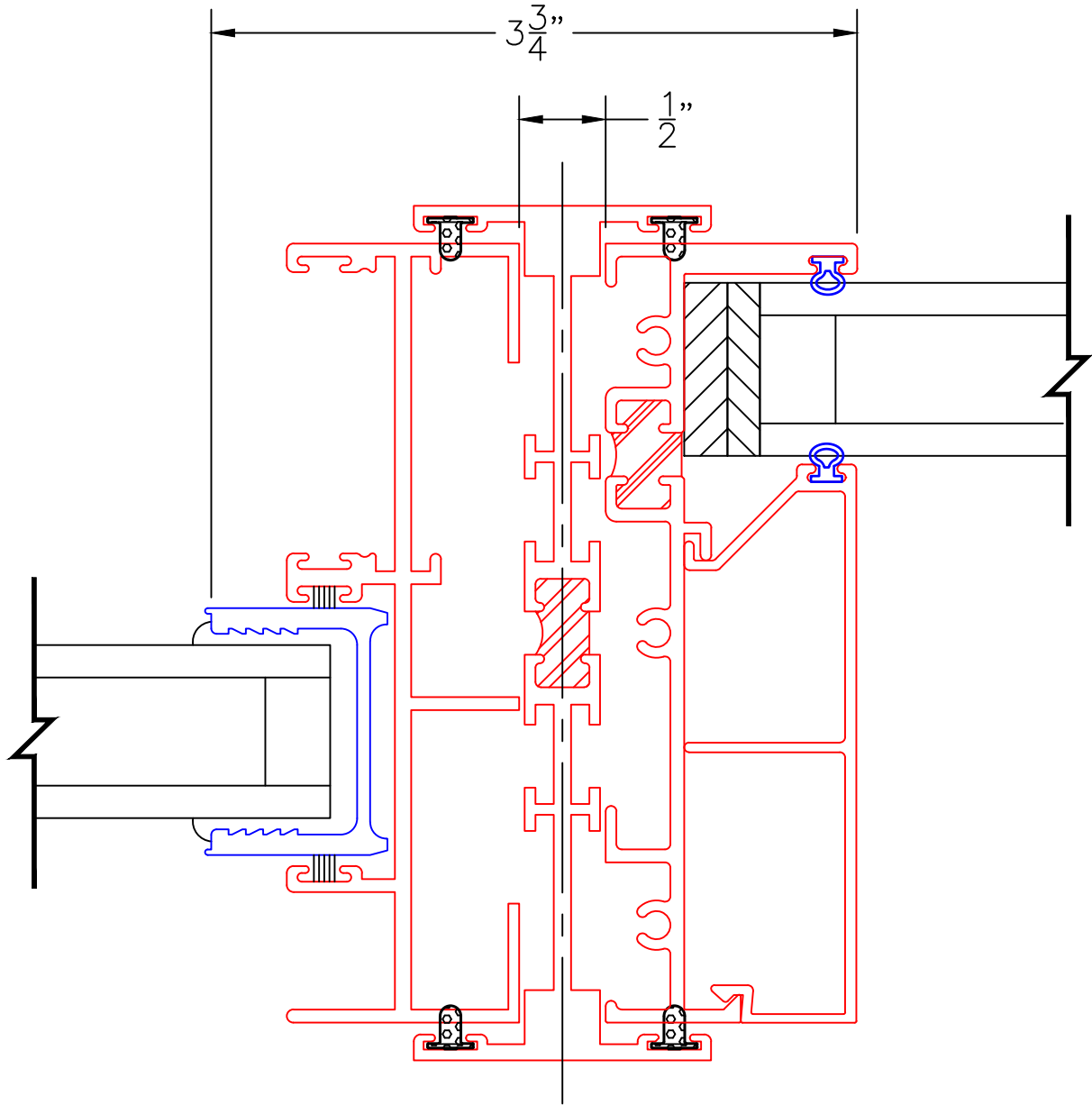

EXTERIOR

SERIES 3000 TO SERIES 3800-T

0 0.5 1
(USE RULER TO SCALE DIMENSIONS IN INCHES)
SCALE: FULL

THERMALLY-BROKEN
JAMB MULLION DETAILS
1" INSULATED GLAZING

1B

JAMB MULLION

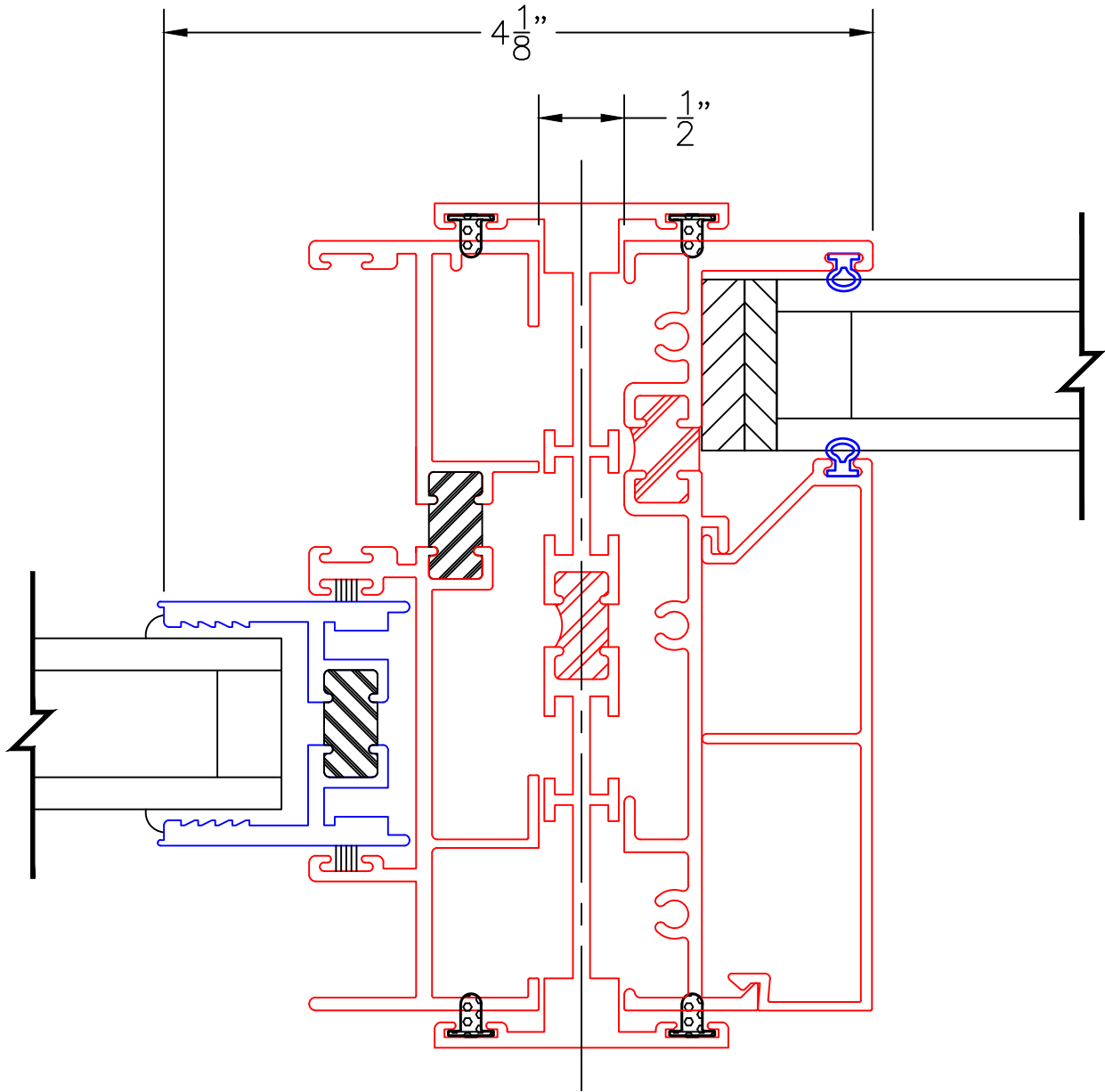

SERIES 3300-T TO SERIES 3800-T

0 0.5 1
(USE RULER TO SCALE DIMENSIONS IN INCHES)
SCALE: FULL

THERMALLY-BROKEN
JAMB MULLION DETAILS
1" INSULATED GLAZING

2

JAMB MULLION

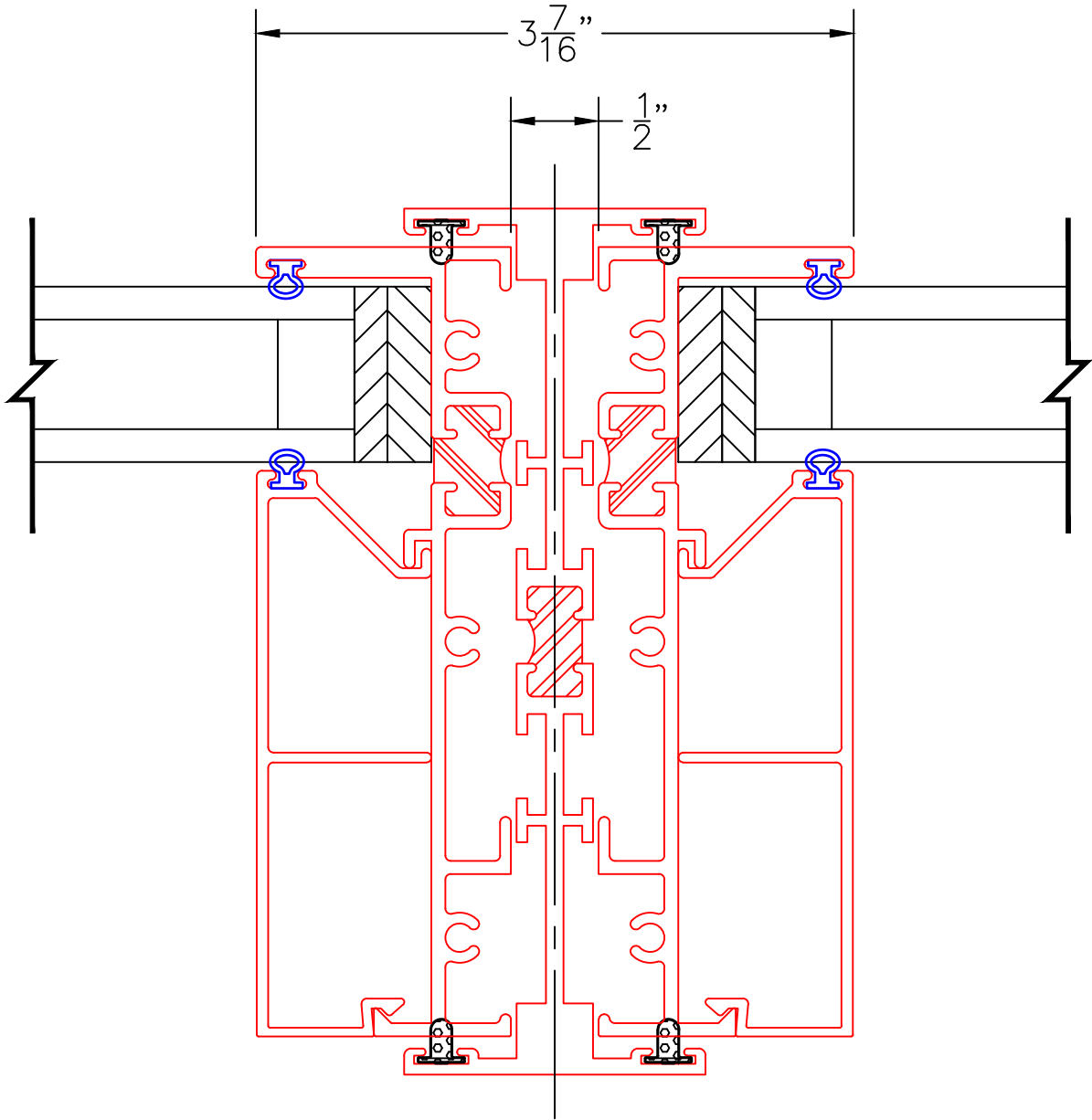





























EXTERIOR

SERIES 3800-T TO SERIES 3800-T

[Architecturals
Click Here](#)
[Product Specs
Click Here](#)

BILL OF MATERIALS

ITEM #	PART#	DESCRIPTION	IMAGE
ALUMINUM EXTRUSIONS			
1	3801	1" GLAZING BEAD	
2	3802	1" BENDABLE GLAZING BEAD	
3	3803	1/4" GLAZING BEAD	
4	3804	9/16" GLAZING BEAD	
5	3805	4.5 FRAME	
6	3806	TDL	
7	3807	1-1/2" SERIES GLASS STOP	
8	3810	2-1/4" SERIES GLASS STOP	
9	3811	1 1/4" GLASS STOP	
10	3812	INTERSECTING MULLION KEY (INTERSECTING TDL)	
11	3814	APPLIED GRID INTERIOR	
12	3815	SHEAR BLOCK (FOR HP ONLY)	
13	FW1194	2.0" x 0.25" ALUMINUM BAR (INTERSECTING TDL HP ONLY)	
14	FW1195	1.5" x 0.25" ALUMINUM BAR (INTERSECTING TDL HP ONLY)	
15		SILL PAN, BLOCK FRAME	
16		SILL PAN, NAIL ON	
17	3082	THERMAL MULLION	
18	3809	4.5 BLOCK FRAME	
19	3816	1 1/4" TIERED GLASS STOP	
20	3817	90° CORNER BUTT GLAZED EXTERIOR CAP/COVER FOR 1.25" GLASS	
21	3818	90° CORNER BUTT GLAZED INTERIOR CAP/COVER FOR 1.25" GLASS	
HARDWARE			
31	VARY BY COLOR	SCREW NO 10, PPH, 1.00"	
32	VARY BY COLOR	SCREW NO 6, PFHU, .50"	
33	VARY BY COLOR	SCREW NO 8, PFH, 1 1/2"	
SEAL & SEALANT			
51	25199	BULB VINYL - MINI (ASTM C864)	
52	25031	BULB VINYL - LARGE (ASTM C864)	
53	19120	Q-LON WEATHERSTRIP (U 5212)	
54	18622	SETTING BLOCK 3/8 X 1 X 4	
55	18621	SETTING BLOCK 1/8 X 1 X 4	
56	23217	RIGID PVC SETTING BLOCK	