

**EXTRAPOLATED QUALIFICATIONS**

FLEETWOOD MANUFACTURES THREE SLIDING DOOR PRODUCTS THAT USE THE SAME SUB-SILLPAN DESIGN. MOST OF THE TESTING WAS PERFORMED ON THE SERIES 3070-HI AND THE INFORMATION COLLECTED ALLOWED THE ENGINEERING DEPARTMENT TO CREATE THIS EXTENSIVE LIST OF WATER PERFORMANCE EXPECTATIONS.

**TEST REPORT LIMITATIONS**

LABORATORY TEST REPORTS ARE USED AS REFERENCE ONLY, SINCE THE TEST SPECIMEN IS NEVER ORDERED VERBATIM. ENGINEERING USED THE TESTING DATA TO EXTRAPOLATE REASONABLE PERFORMANCE EXPECTATIONS OF A NUMBER OF CONFIGURATIONS AND STACKING ORIENTATIONS.

**REASONABLE EXPECTATIONS**

FLEETWOOD VERIFIES THE EXTRAPOLATED WATER PERFORMANCES (NOTED BELOW) WERE DERIVED SCIENTIFICALLY. CUSTOMERS CAN EXPECT SUCH PERFORMANCE IN A LABORATORY, BUT NOT IN THE FIELD. AAMA STATES THAT FIELD CONDITIONS MUST EXPECT 2/3 THAT OF A LABORATORY PERFORMANCE. CUSTOMERS THEREFORE SHOULD FACTOR THIS MITIGATING VALUE INTO THE FINAL PRODUCT CHOICE.

**SUPPORTING DOCUMENTS** (CLICK ON THE TEST REPORT FOR FURTHER DETAILS)

**SERIES    TEST REPORT NUMBER**

3070	T12-004 ; T12-004-1
3070-T	E8392.01-301-44
3070-HI	E8391.01-301-44 ; E8391.03-301-18

NON-POCKET DOOR WITH FULL PAN AND TRACKS;  
 XXX AND OXX DOORS SHOWN

XXX DOORS

OXX DOORS

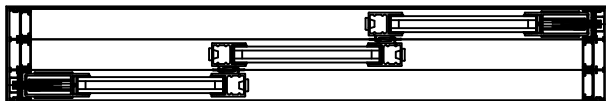

EXTERIOR                      WATER 6 PSF

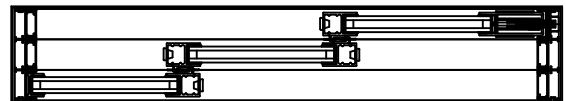

EXTERIOR                      WATER 6 PSF

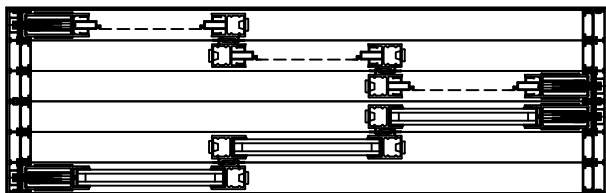

EXTERIOR                      WATER 6 PSF

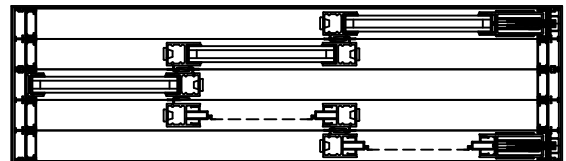

EXTERIOR                      WATER 4.5 PSF

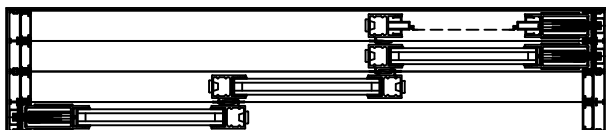

EXTERIOR                      WATER 6 PSF

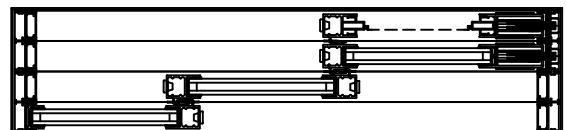

EXTERIOR                      WATER 6 PSF

NON-POCKET DOOR WITH STAGGERED PAN AND TRACKS;  
 OXX DOORS SHOWN (FULL PAN WITH STAGGERED TRACKS SIMILAR)

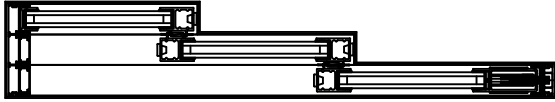

EXTERIOR WATER 4.5 PSF  
 (BOTTOM DRAIN ONLY)

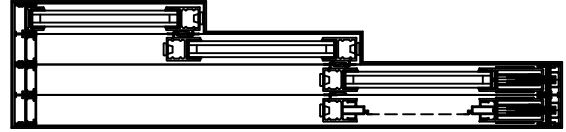

EXTERIOR WATER 4.5 PSF

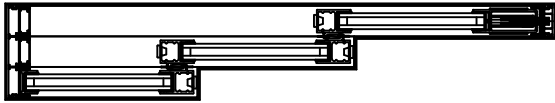

EXTERIOR WATER 9 PSF

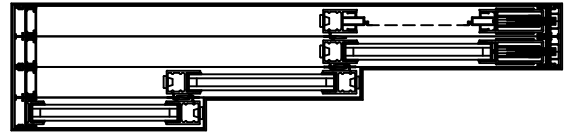

EXTERIOR WATER 9 PSF

POCKET DOOR WITH FULL PAN AND TRACKS;  
 PXXX DOORS SHOWN

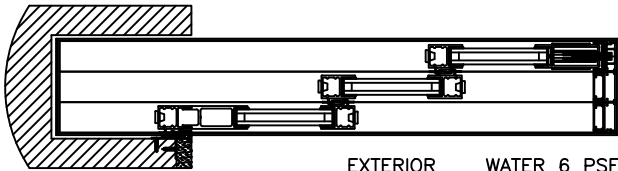

EXTERIOR WATER 6 PSF

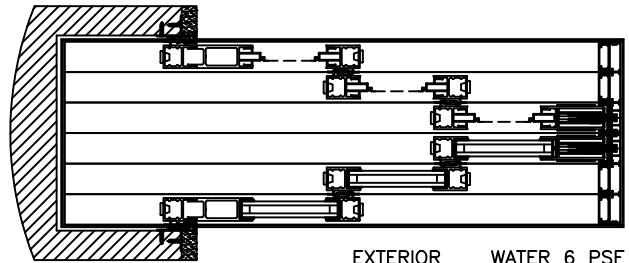

EXTERIOR WATER 6 PSF

POCKET DOOR WITH STAGGERED PAN AND TRACKS;  
 PXXX DOORS SHOWN (FULL PAN WITH STAGGERED TRACKS SIMILAR)

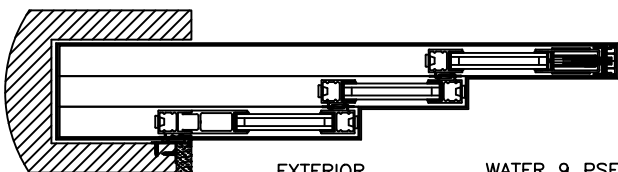

EXTERIOR WATER 9 PSF

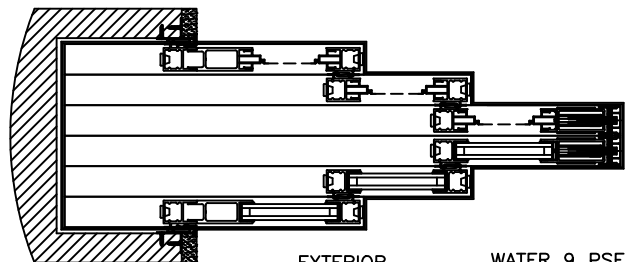

EXTERIOR WATER 9 PSF

NON-POCKET 90° CORNER DOOR WITH FULL PAN AND TRACKS;  
90°XXXVXXX DOORS SHOWN

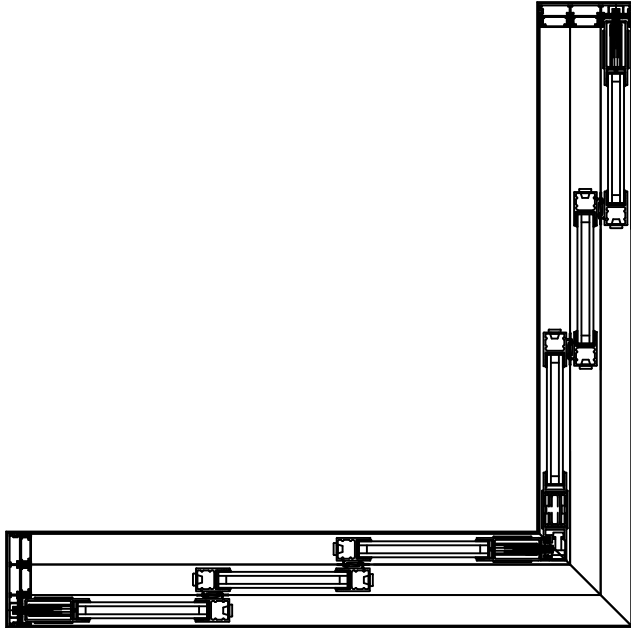

WATER 6 PSF EXTERIOR

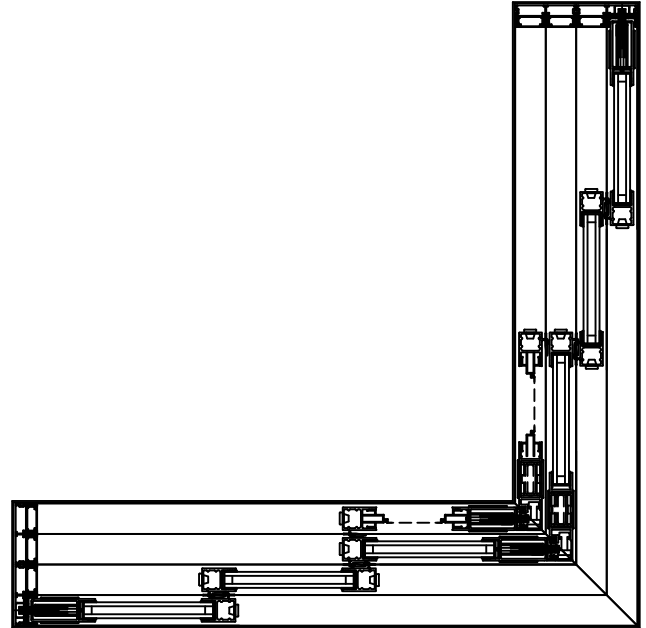

WATER 6 PSF EXTERIOR

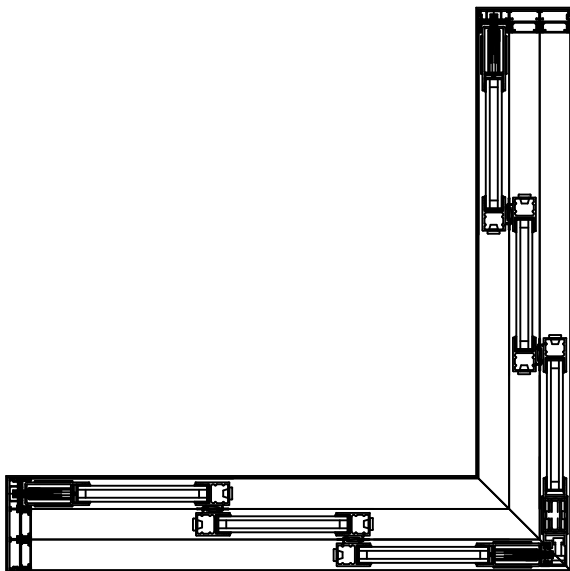

WATER 6 PSF EXTERIOR

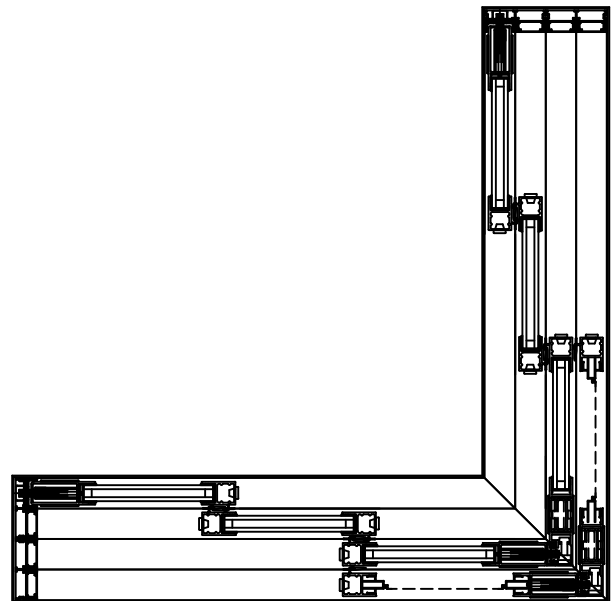

WATER 6 PSF EXTERIOR

NON-POCKET 90° CORNER DOOR WITH STAGGERED PAN AND TRACKS;  
 90°OXXVXXO DOORS SHOWN (FULL PAN WITH STAGGERED TRACKS SIMILAR)

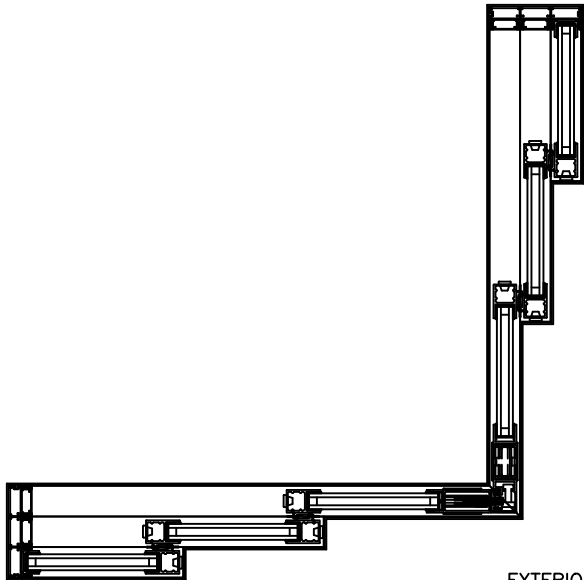

EXTERIOR  
 WATER 9 PSF

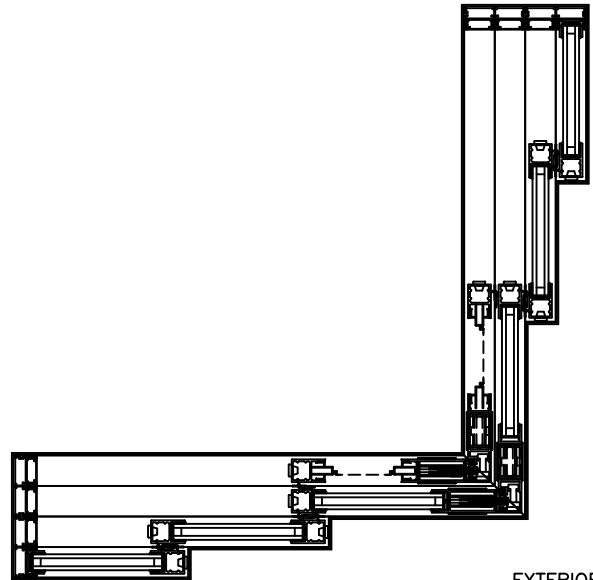

EXTERIOR  
 WATER 9 PSF

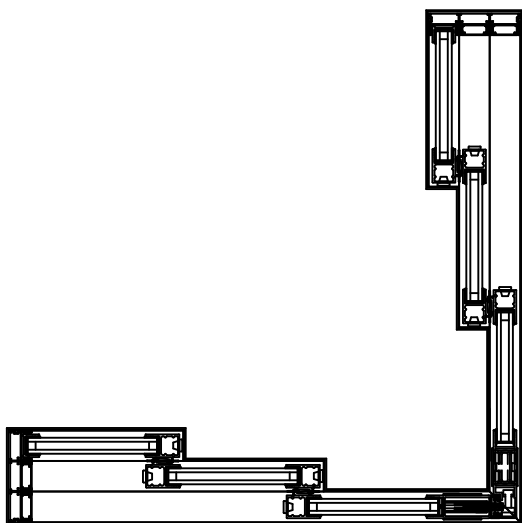

WATER 4.5 PSF  
 (BOTTOM DRAIN ONLY) EXTERIOR

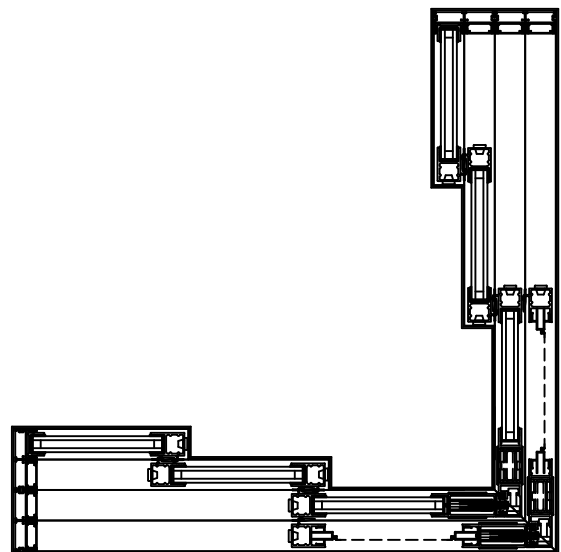

WATER 4.5 PSF EXTERIOR

NON-POCKET 90° CORNER DOOR WITH FULL PAN AND TRACKS;  
90°XXXVXXX DOOR SHOWN

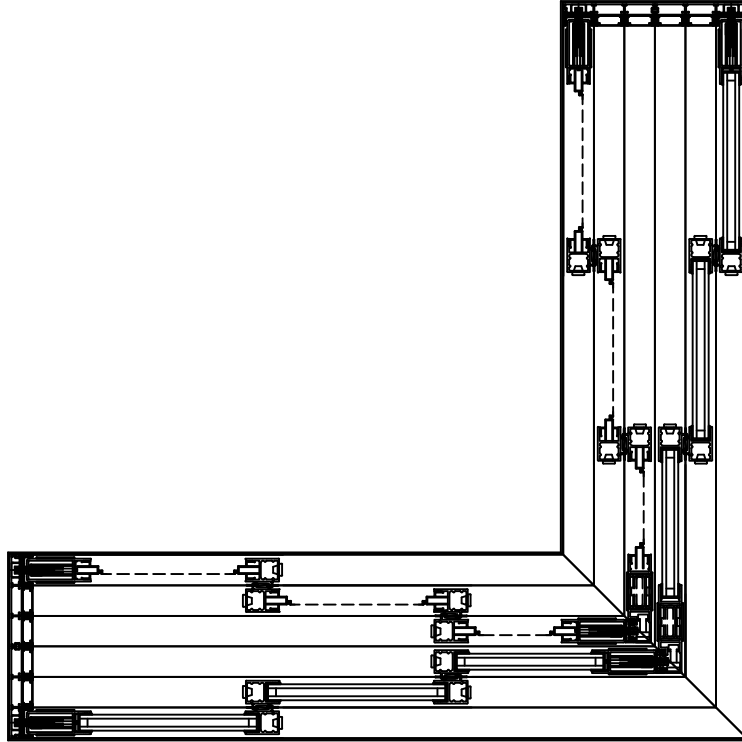

WATER 6 PSF      EXTERIOR

POCKET 90° CORNER DOOR WITH STAGGERED PAN AND TRACKS;  
90°PXXXVXXXP DOOR SHOWN (FULL PAN WITH STAGGERED TRACKS SIMILAR)

