

(USE RULER TO SCALE DIMENSIONS IN INCHES)  
**SCALE: 1/4**

**MULTI-SLIDE CORNER DOOR DETAILS**

OXXVXXP SHOWN

NOTE: CENTERLINES ARE NOT DIVIDED EQUALLY;  
CONFIRM CENTERLINES WHEN REQUIRED.

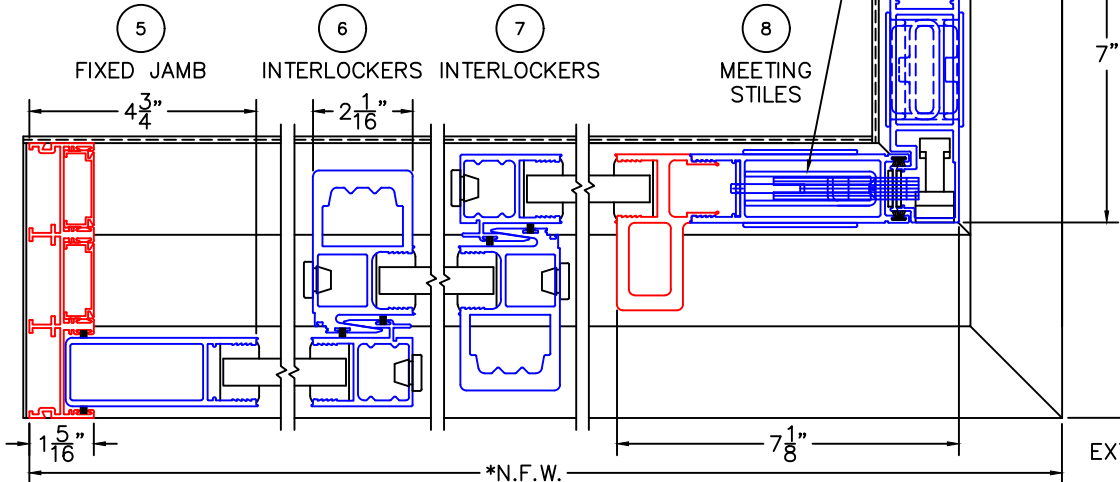
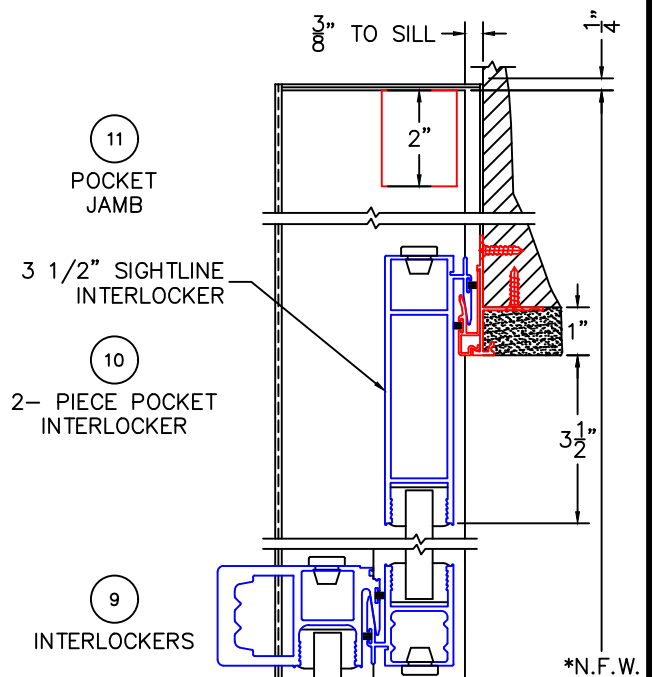
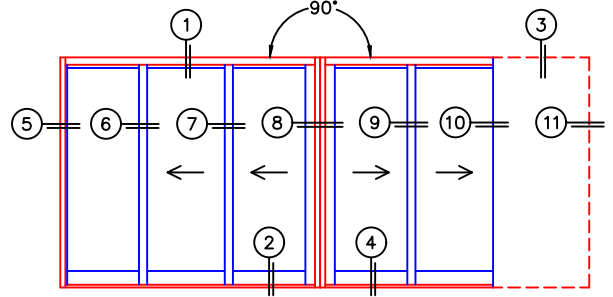
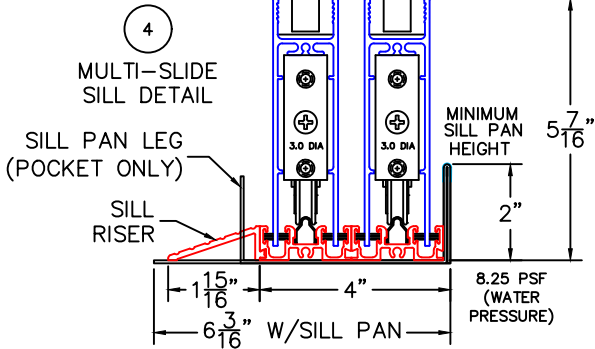
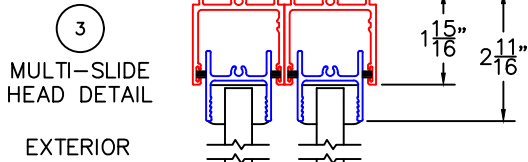
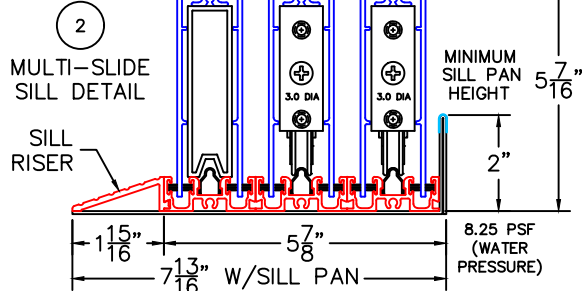
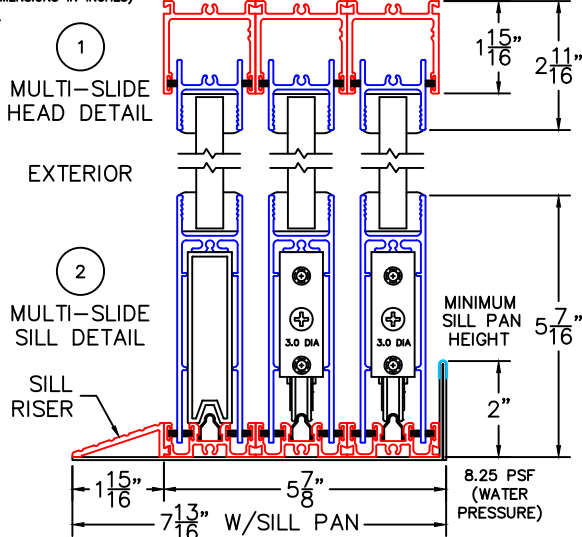

ARCHETYPE LATCH WITH FLUSH PULL HANDLES

-\*NET FRAME WIDTH DOES NOT INCLUDE SILL PAN.  
-SILL PAN EXTENDS 1/8" BEYOND EACH JAMB.  
-PLAN VIEW DOES NOT SHOW RISER.

-GLASS PENETRATION: 11/16"  
-EXTERIOR RATED PRODUCTS HAVE  
WEEP SLOTS ON HORIZONTAL SILLS.

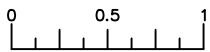

(USE RULER TO SCALE DIMENSIONS IN INCHES)

SCALE: FULL

OXX DOOR

1

MULTI-SLIDE  
HEAD DETAIL

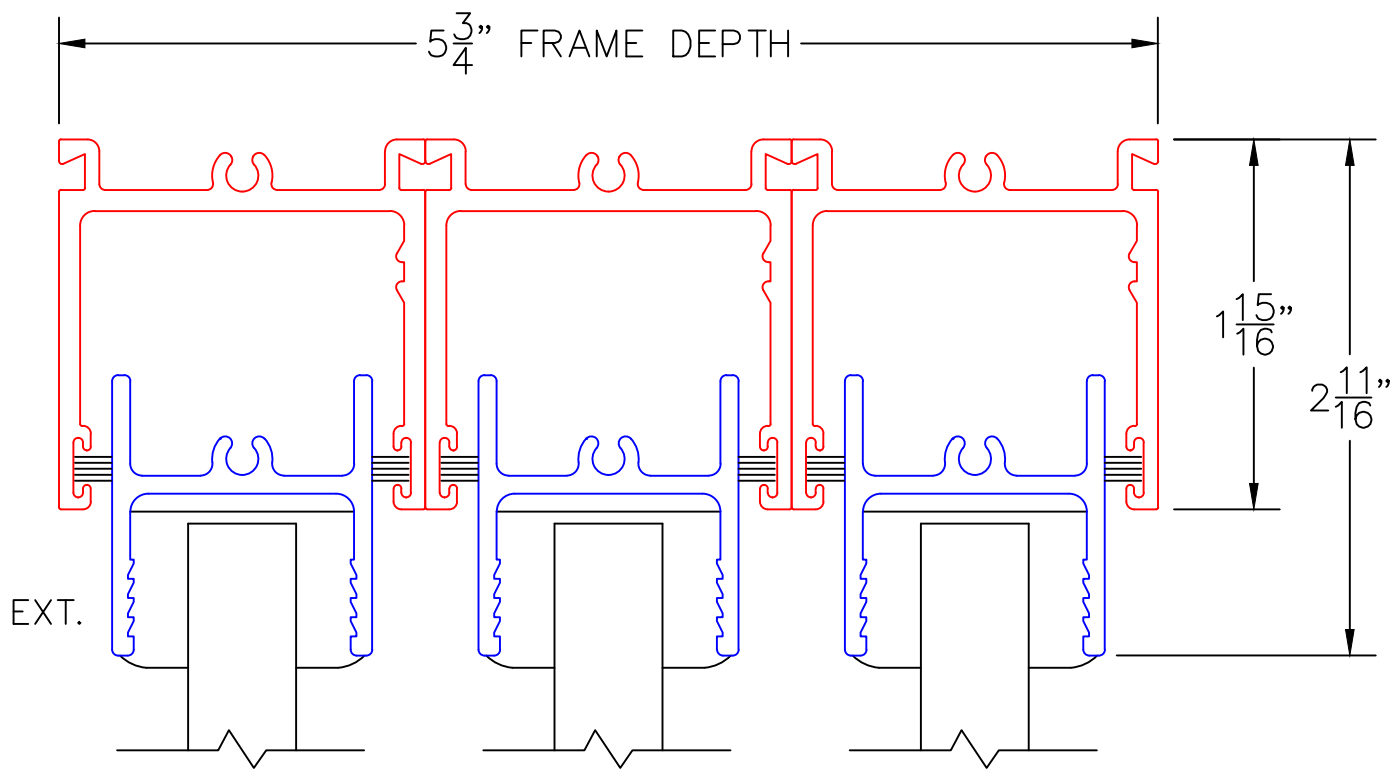

0 0.5 1  
(USE RULER TO SCALE DIMENSIONS IN INCHES)  
**SCALE: FULL**

OXX DOOR

EXTERIOR

2

MULTI-SLIDE  
SILL DETAIL

A3 ROLLERS

SILL RISER

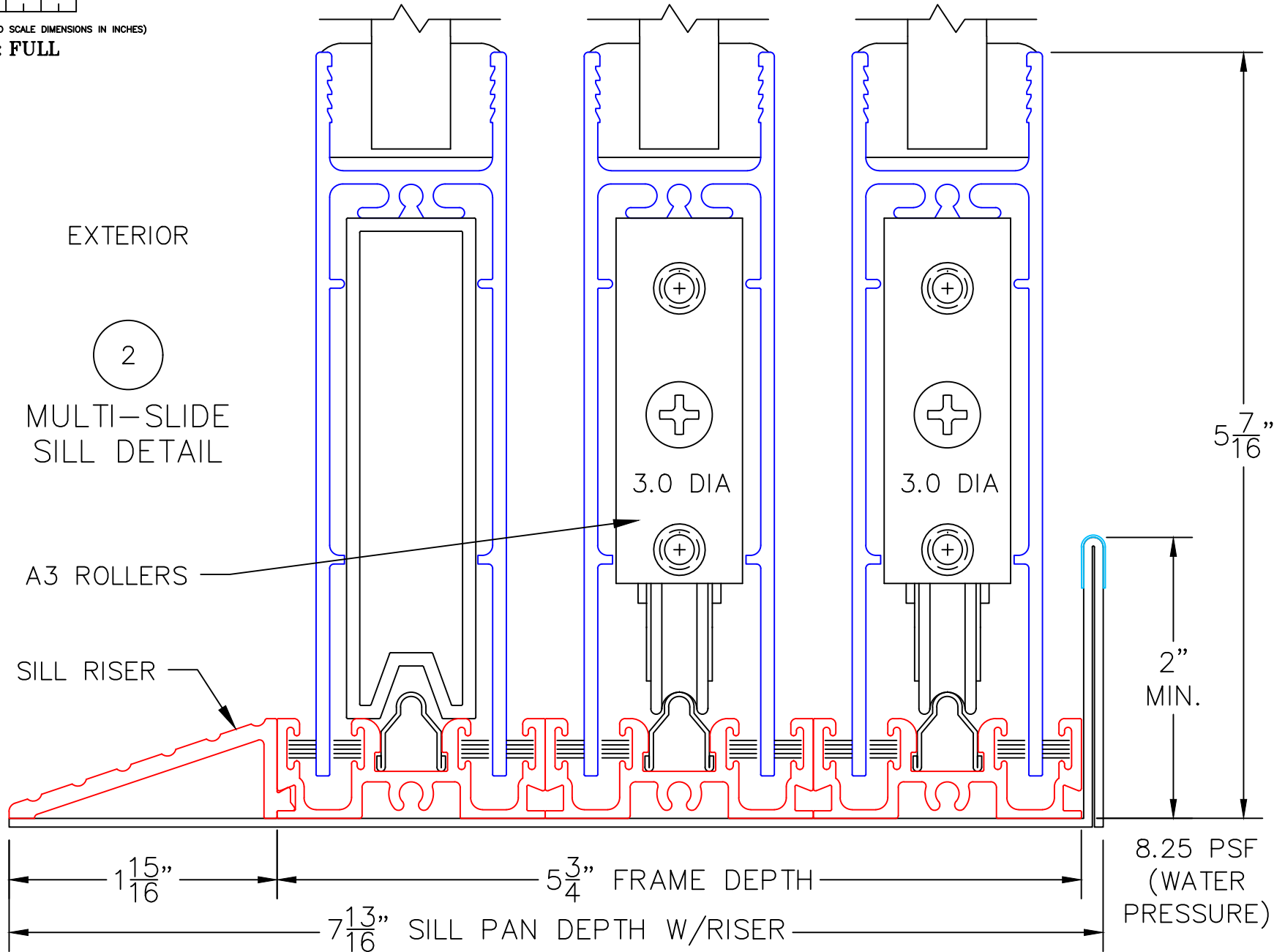

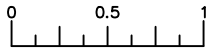

(USE RULER TO SCALE DIMENSIONS IN INCHES)

SCALE: FULL

XXP DOOR

3  
MULTI-SLIDE  
HEAD DETAIL

EXTERIOR

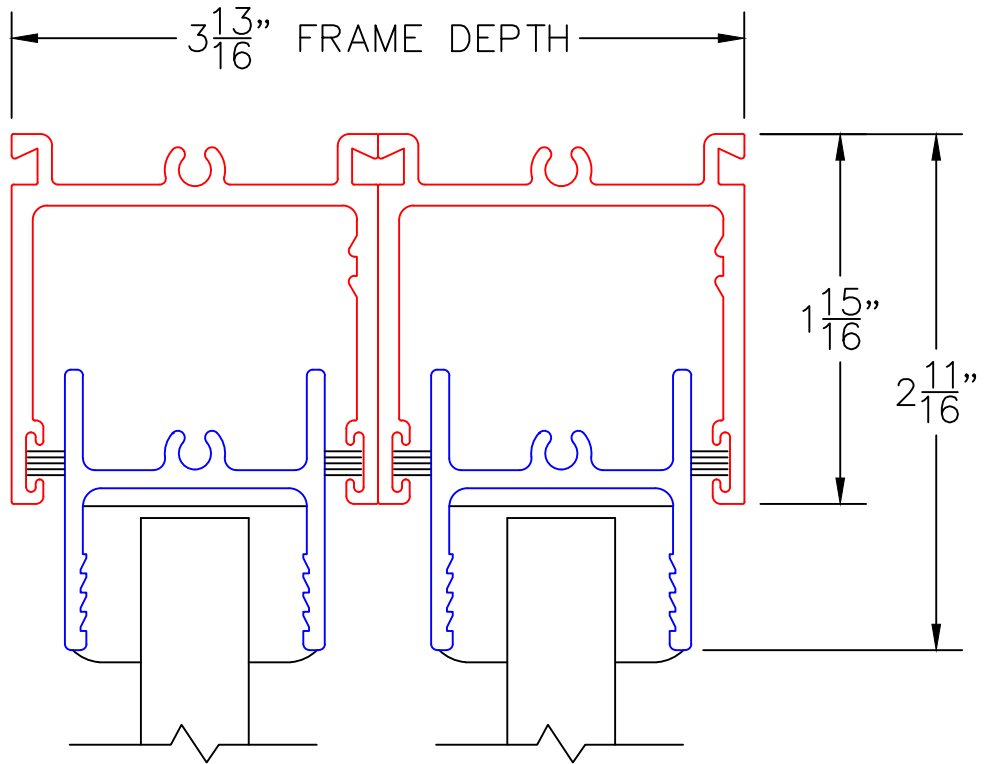

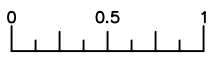

(USE RULER TO SCALE DIMENSIONS IN INCHES)

**SCALE: FULL**

XXP DOOR

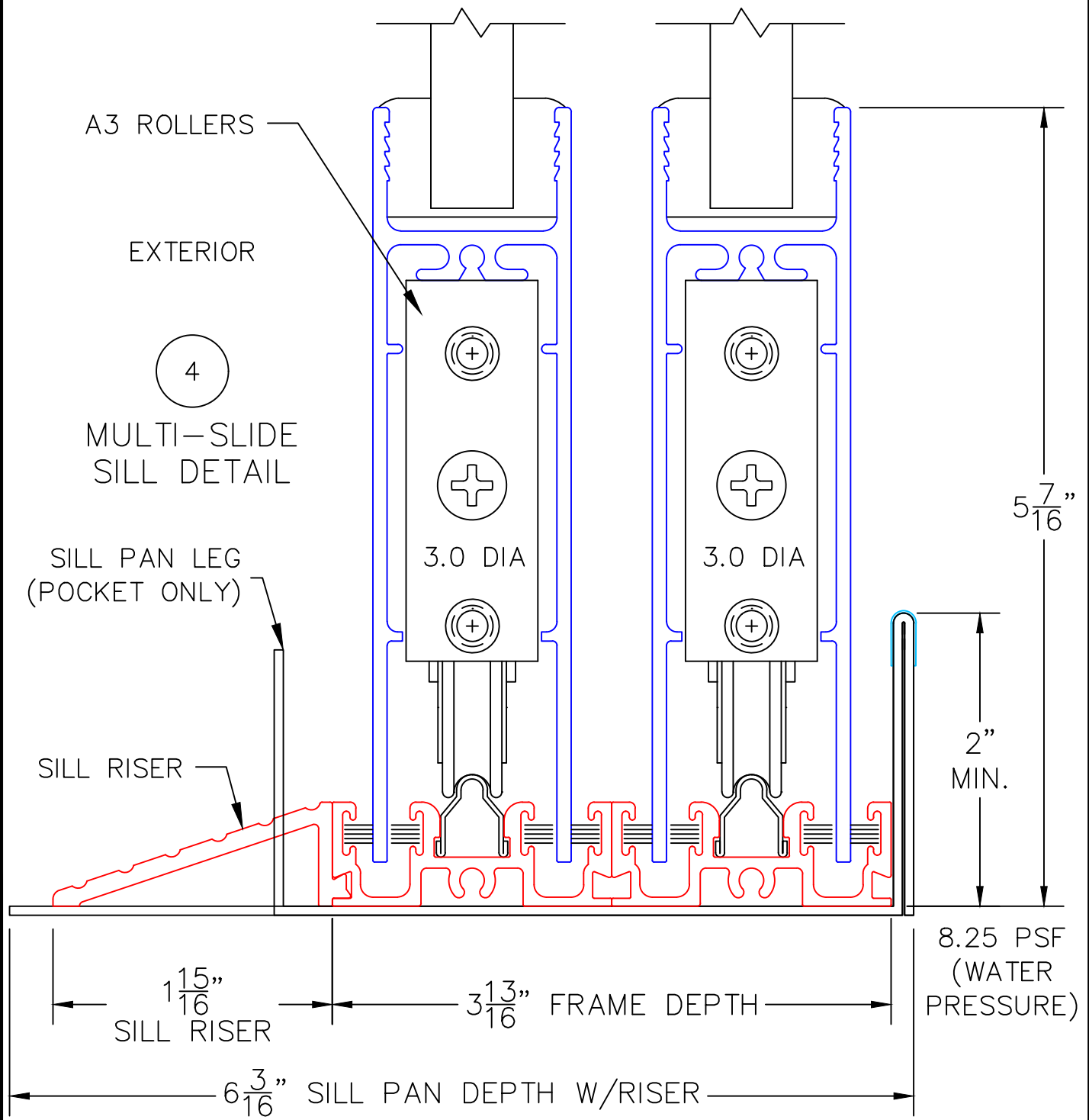

A3 ROLLERS

EXTERIOR

4

MULTI-SLIDE  
SILL DETAIL

SILL PAN LEG  
(POCKET ONLY)

SILL RISER

3.0 DIA

3.0 DIA

5 <sup>7</sup>/<sub>16</sub>"

2"  
MIN.

8.25 PSF  
(WATER  
PRESSURE)

1 <sup>15</sup>/<sub>16</sub>"  
SILL RISER

3 <sup>13</sup>/<sub>16</sub>" FRAME DEPTH

6 <sup>3</sup>/<sub>16</sub>" SILL PAN DEPTH W/RISER

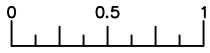

(USE RULER TO SCALE DIMENSIONS IN INCHES)

**SCALE: FULL**

OXX DOOR

5

FIXED JAMB

$\frac{1}{8}$ " FOR  
SILL PAN

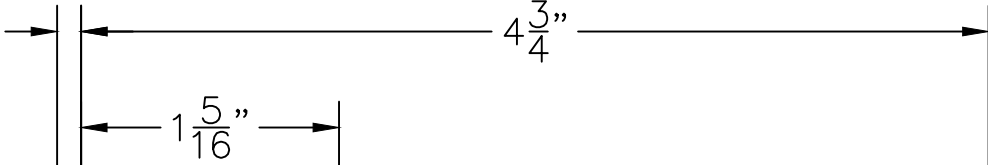

$5\frac{3}{4}$ "  
FRAME  
DEPTH

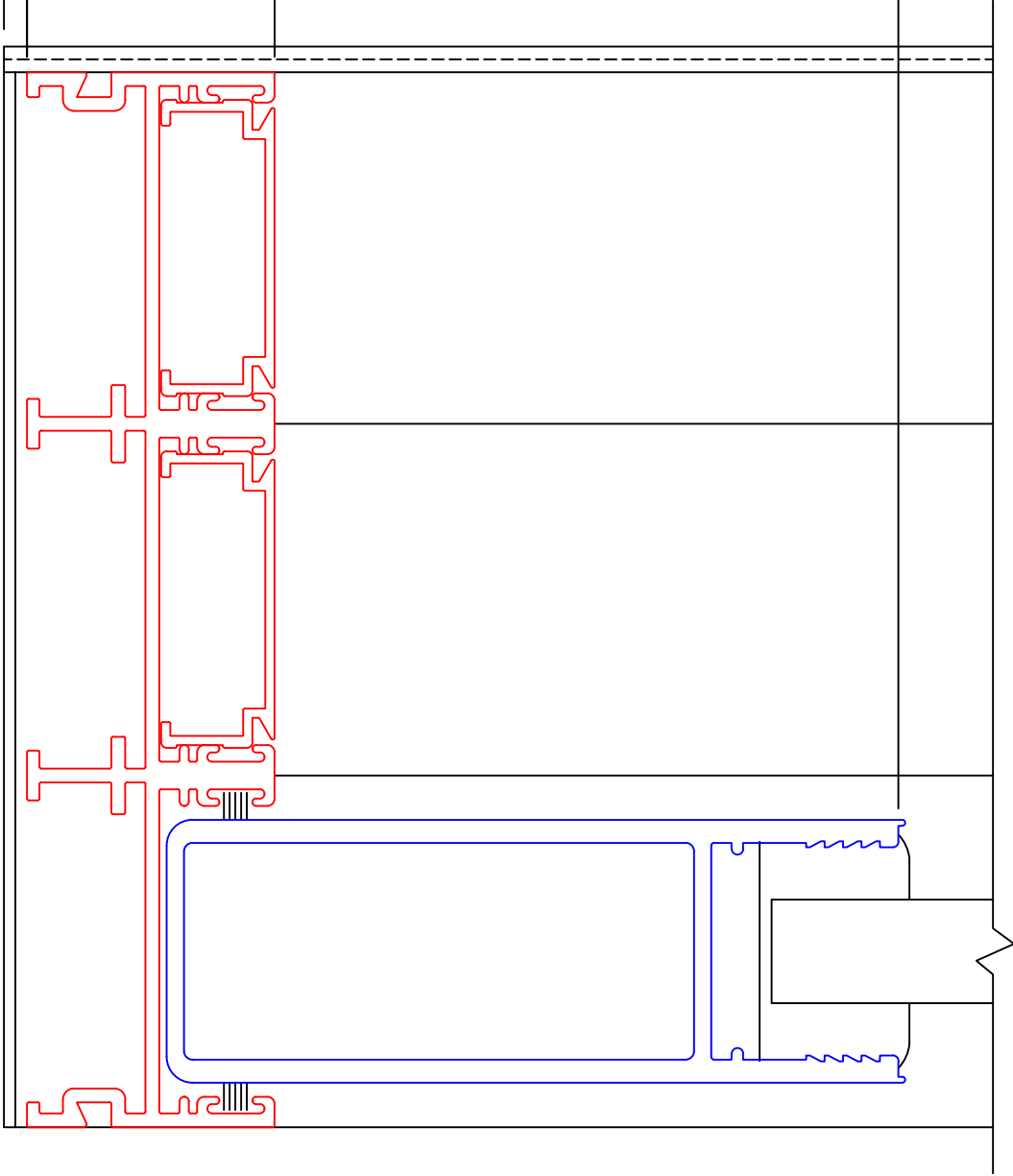

EXTERIOR

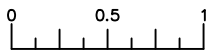

(USE RULER TO SCALE DIMENSIONS IN INCHES)

SCALE: FULL

OXX DOOR

6

INTERLOCKERS

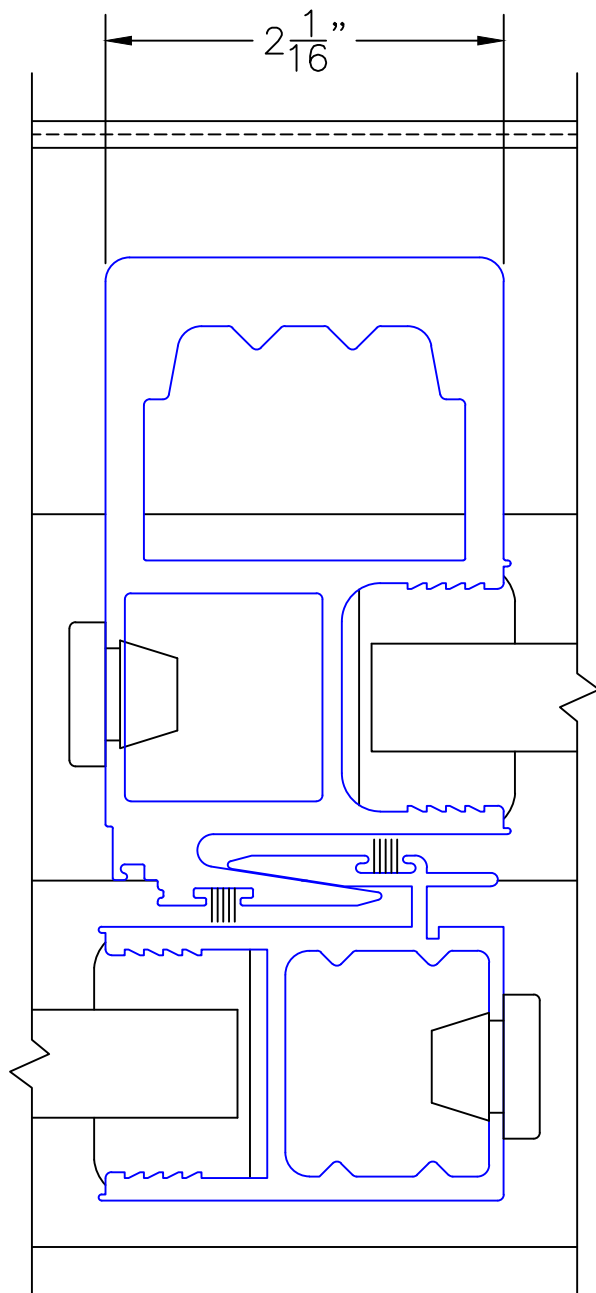

EXTERIOR

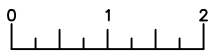

(USE RULER TO SCALE DIMENSIONS IN INCHES)

SCALE: 1/2

OXXVXXP DOOR

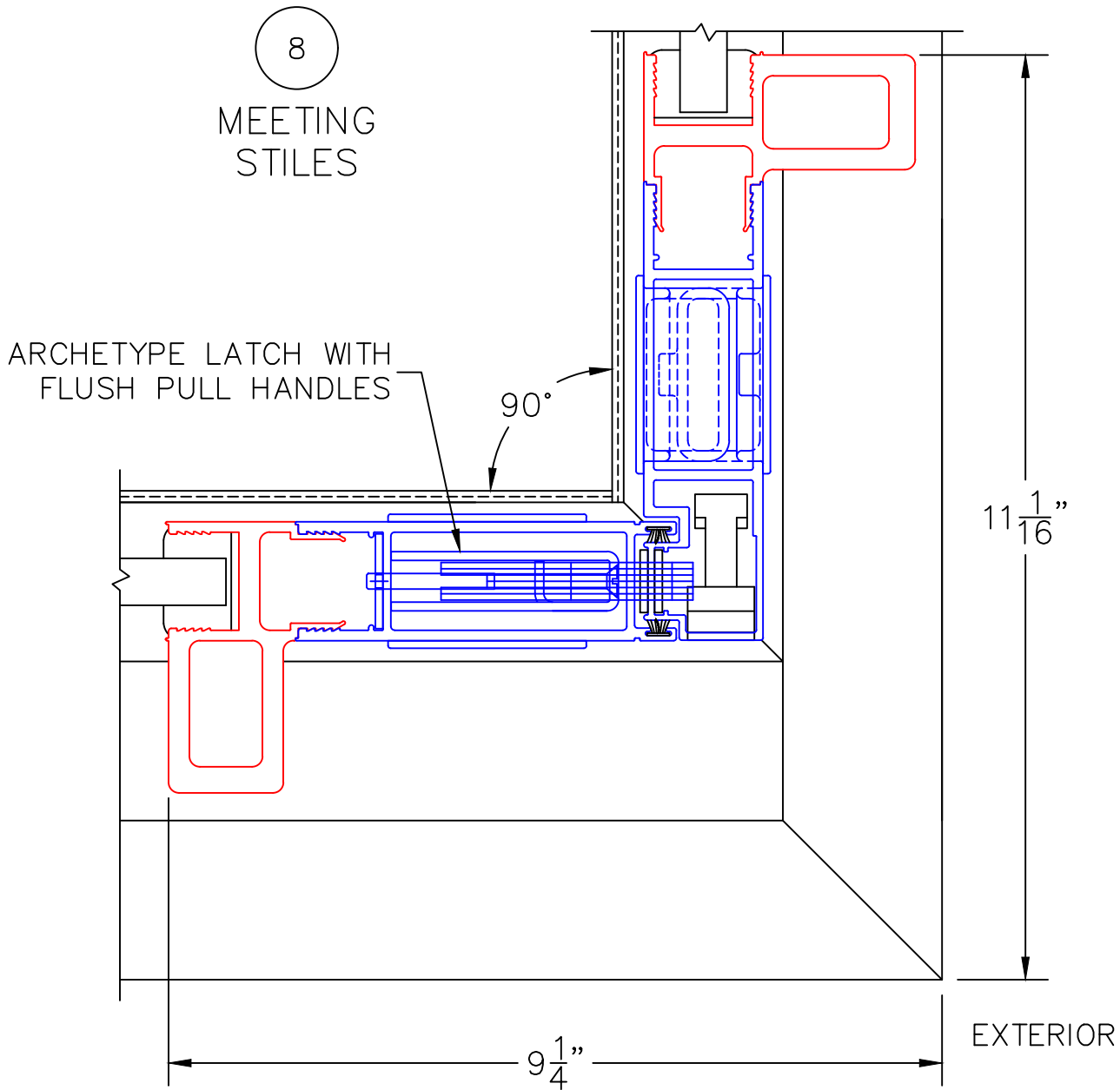



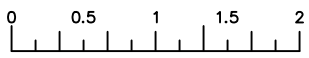

(USE RULER TO SCALE DIMENSIONS IN INCHES)

SCALE: 3/4

XXP DOOR

