

(USE RULER TO SCALE DIMENSIONS IN INCHES)
SCALE: 1/4

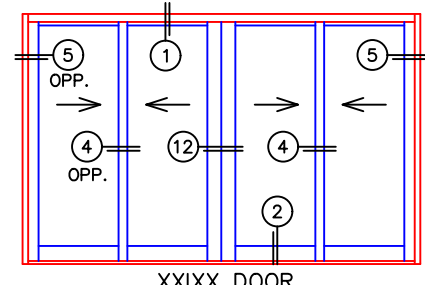

NOTE: CENTERLINES ARE NOT DIVIDED EQUALLY; CONFIRM CENTERLINES WHEN REQUIRED.

-*NET FRAME WIDTH DOES NOT INCLUDE SILL PAN. -GLASS PENETRATION: 11/16"
-SILL PAN EXTENDS 1/8" BEYOND EACH JAMB. -EXTERIOR RATED PRODUCTS HAVE
-PLAN VIEW DOES NOT SHOW RISER. WEEP SLOTS ON HORIZONTAL SILLS.

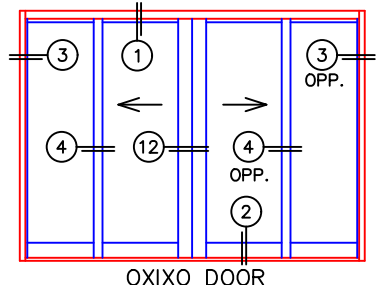
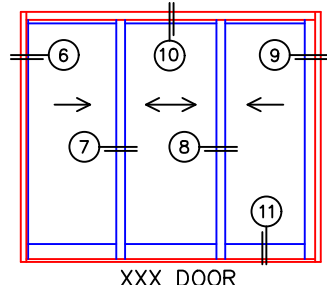
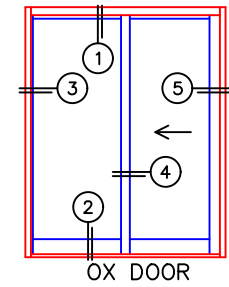
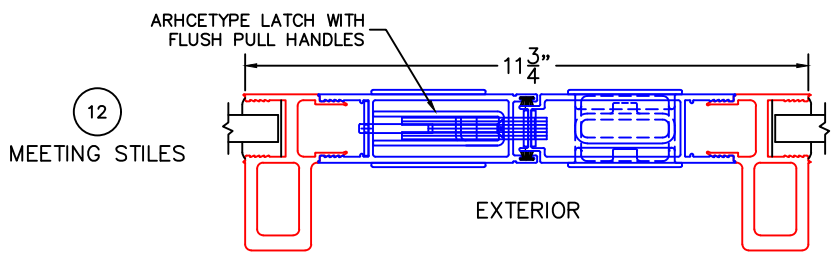
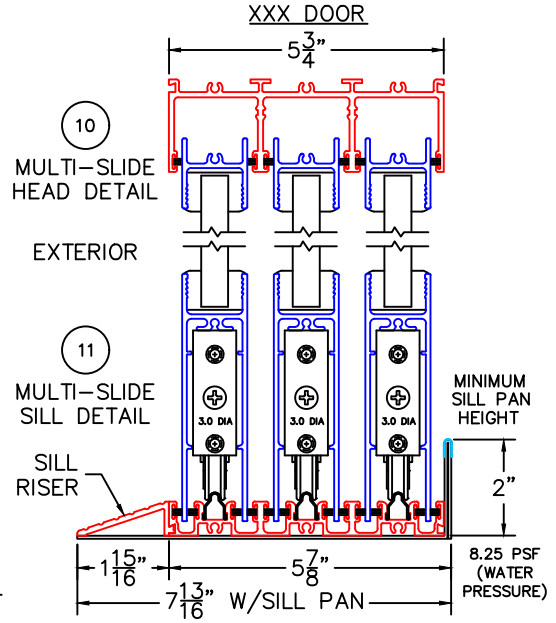
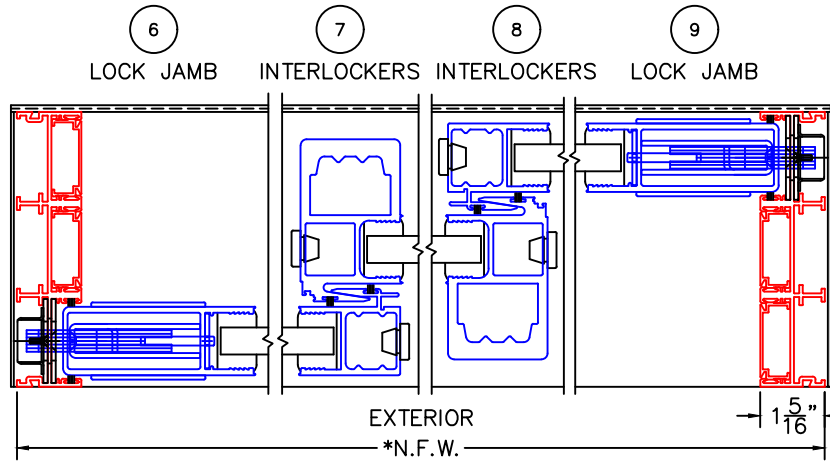
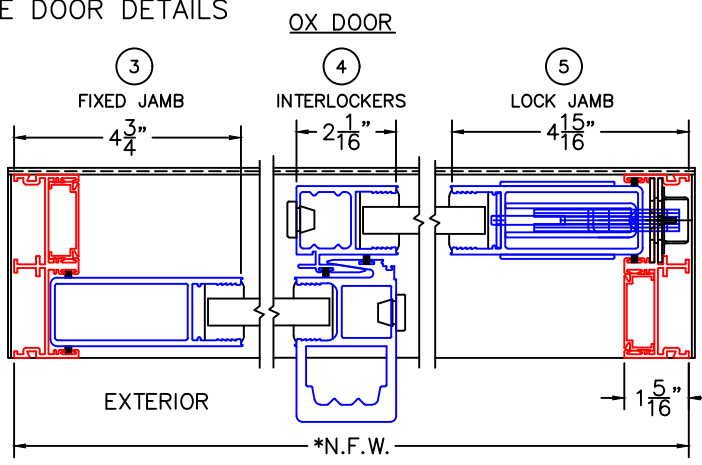
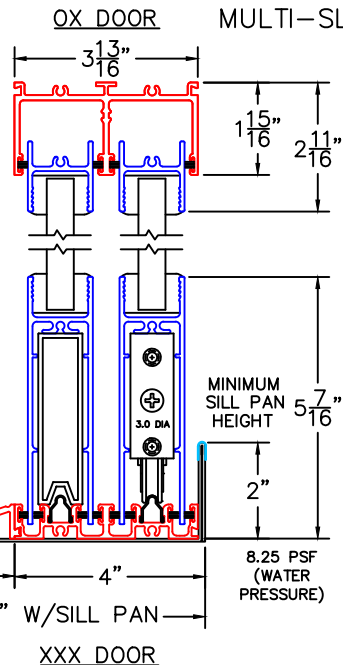
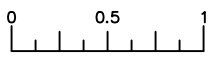

(USE RULER TO SCALE DIMENSIONS IN INCHES)

SCALE: FULL

OX DOOR

①
MULTI-SLIDE
HEAD DETAIL

EXTERIOR

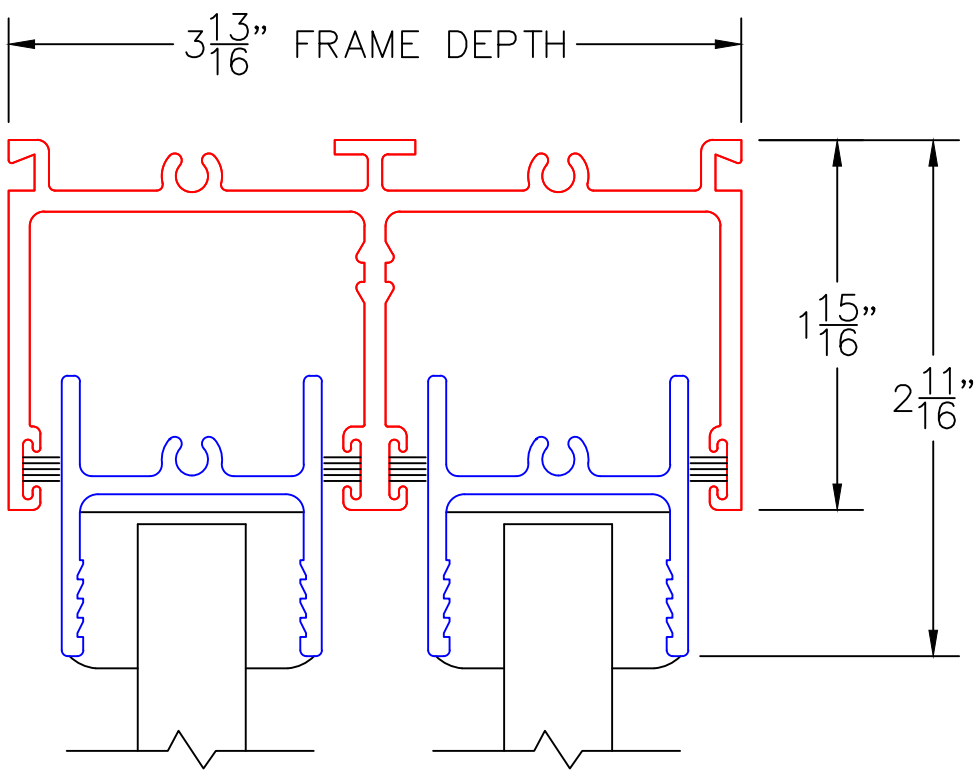

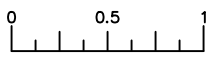

(USE RULER TO SCALE DIMENSIONS IN INCHES)

SCALE: FULL

OX DOOR

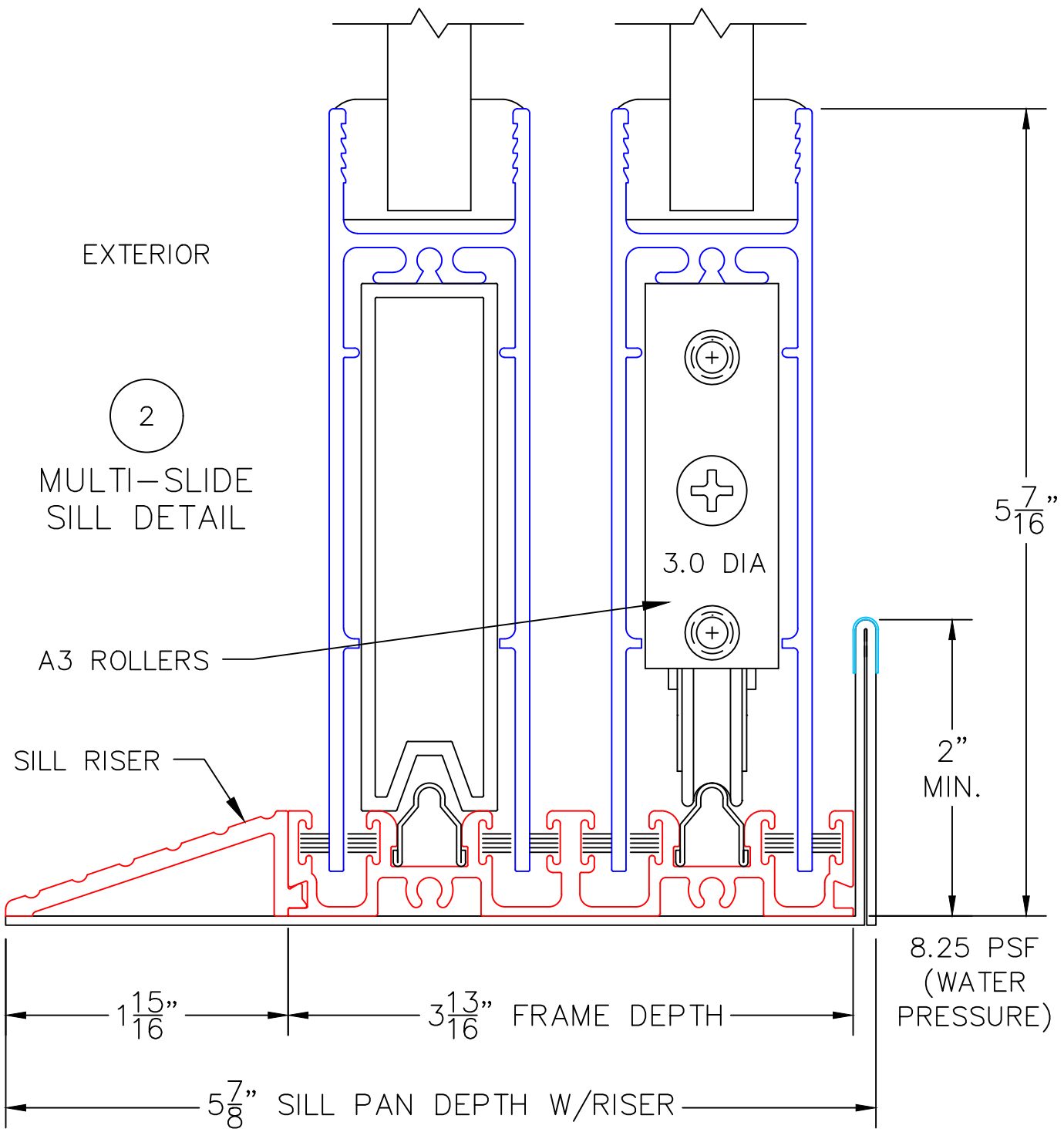

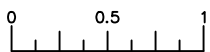

(USE RULER TO SCALE DIMENSIONS IN INCHES)

SCALE: FULL

OX DOOR

3

FIXED JAMB

$\frac{1}{8}$ " FOR
SILL PAN

$4\frac{3}{4}$ "

$1\frac{5}{16}$ "

$3\frac{13}{16}$ "
FRAME
DEPTH

EXTERIOR

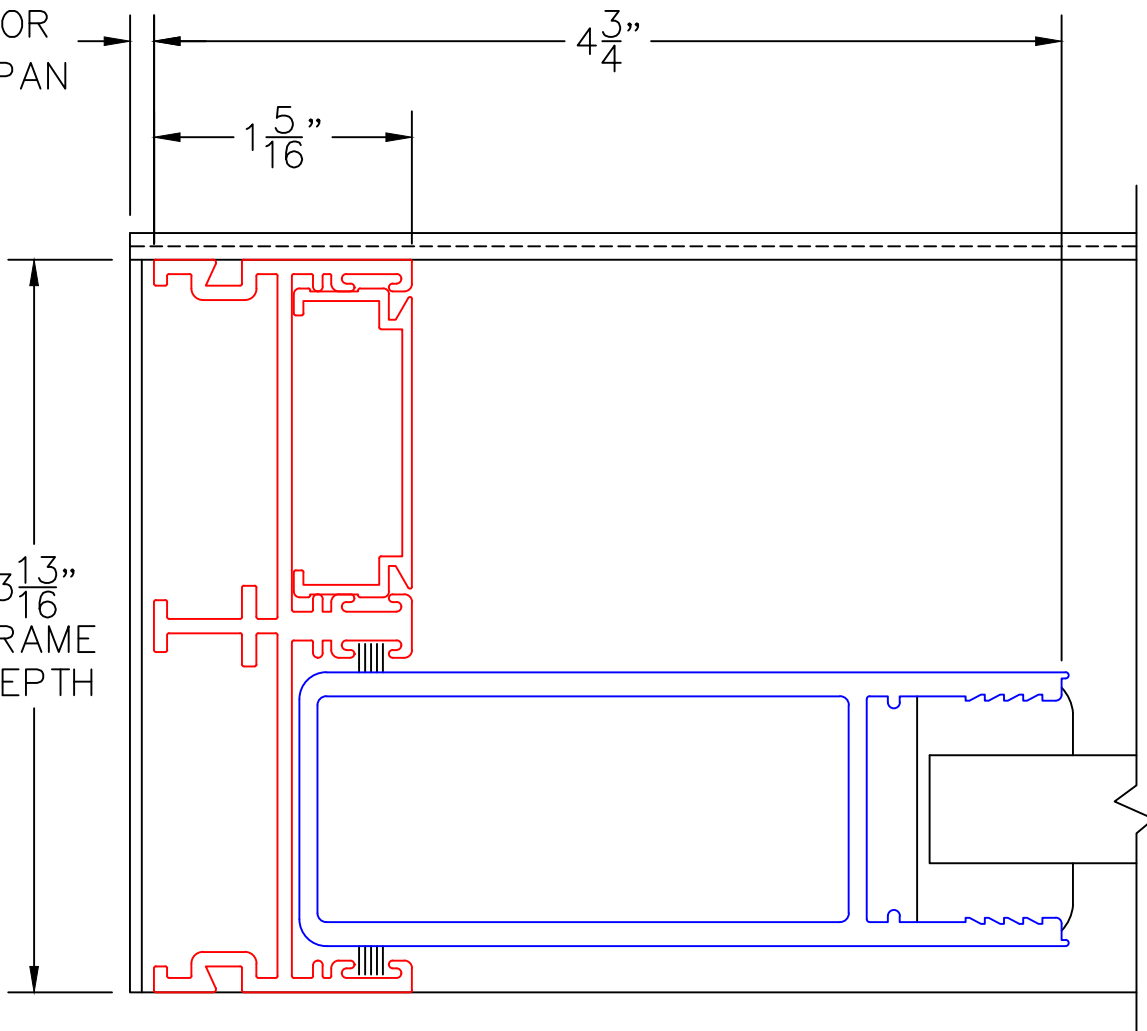

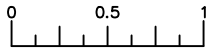

(USE RULER TO SCALE DIMENSIONS IN INCHES)

SCALE: FULL

OX DOOR

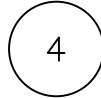

INTERLOCKERS

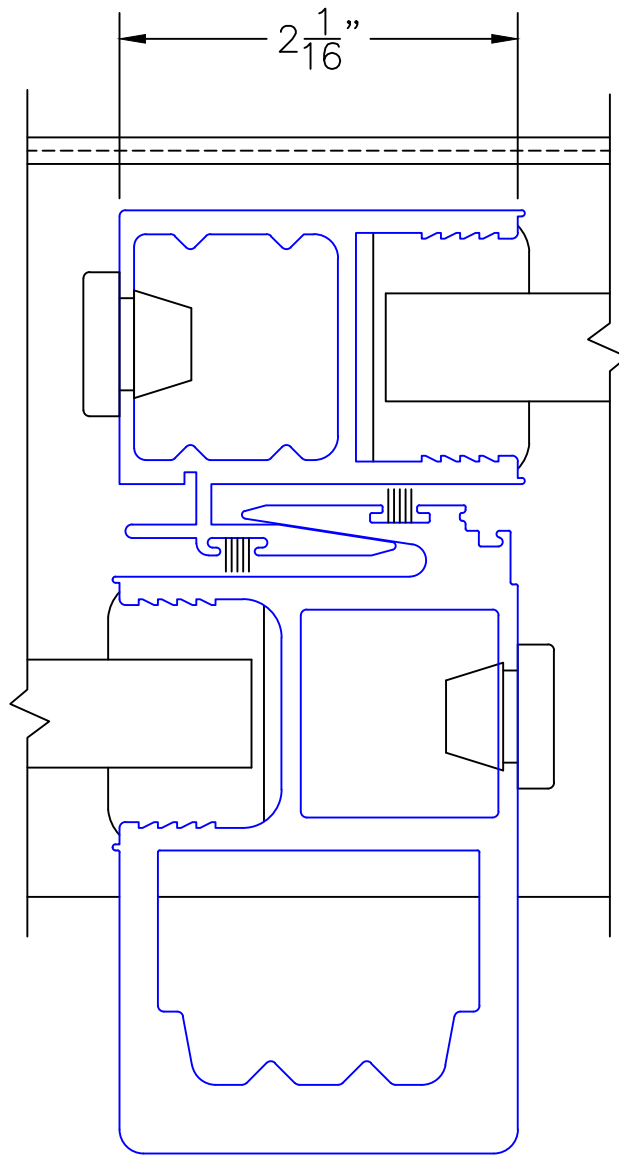

EXTERIOR

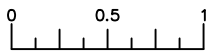

(USE RULER TO SCALE DIMENSIONS IN INCHES)

SCALE: FULL

OX DOOR

5

LOCK JAMB

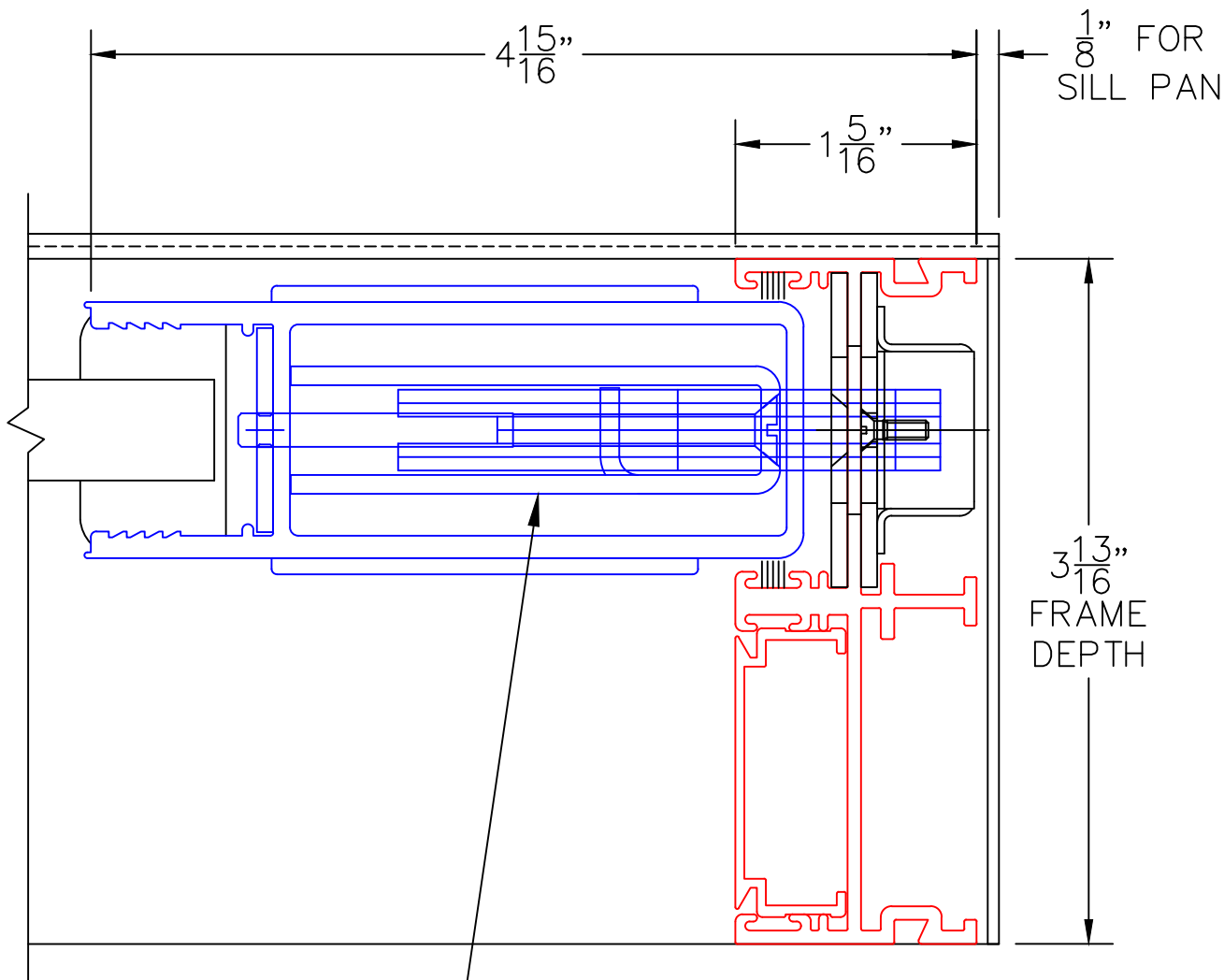

ARCHETYPE LATCH WITH
FLUSH PULL HANDLES

EXTERIOR

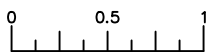

(USE RULER TO SCALE DIMENSIONS IN INCHES)

SCALE: FULL

XXX DOOR

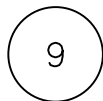

LOCK JAMB

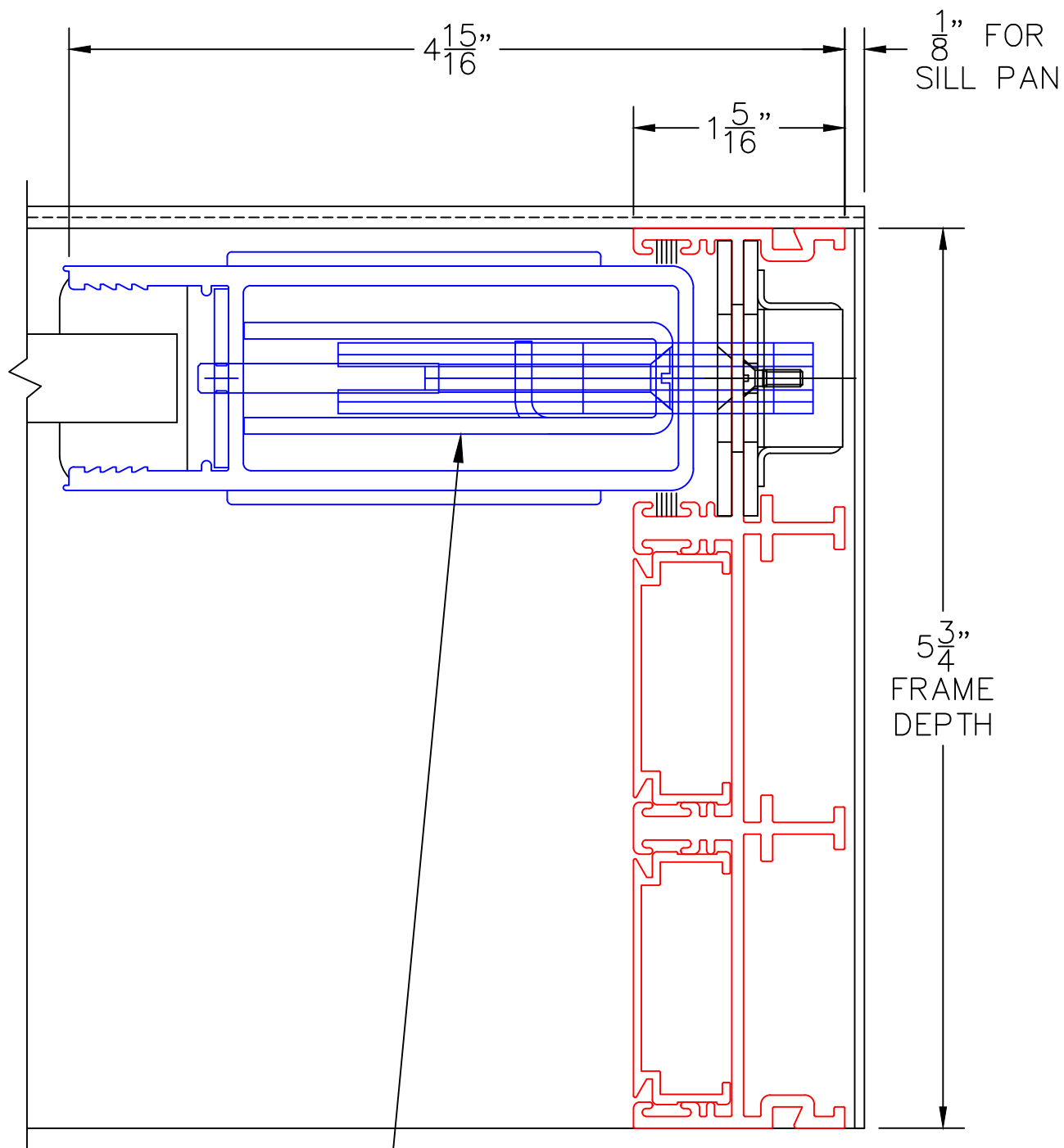

ARCHETYPE LATCH WITH
FLUSH PULL HANDLES

EXTERIOR

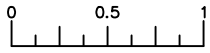

(USE RULER TO SCALE DIMENSIONS IN INCHES)

SCALE: FULL

XXX DOOR

10

MULTI-SLIDE
HEAD DETAIL

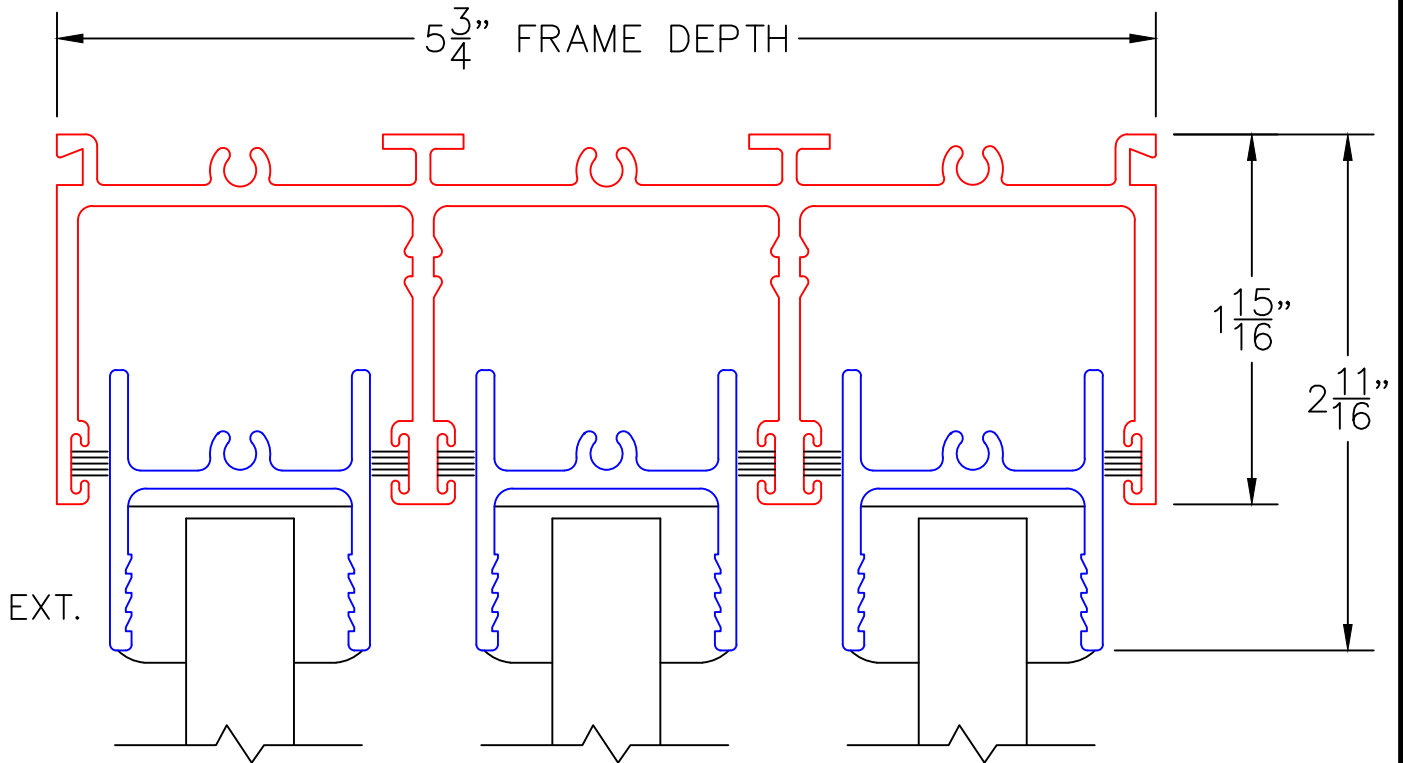

0 0.5 1
(USE RULER TO SCALE DIMENSIONS IN INCHES)
SCALE: FULL

XXX DOOR

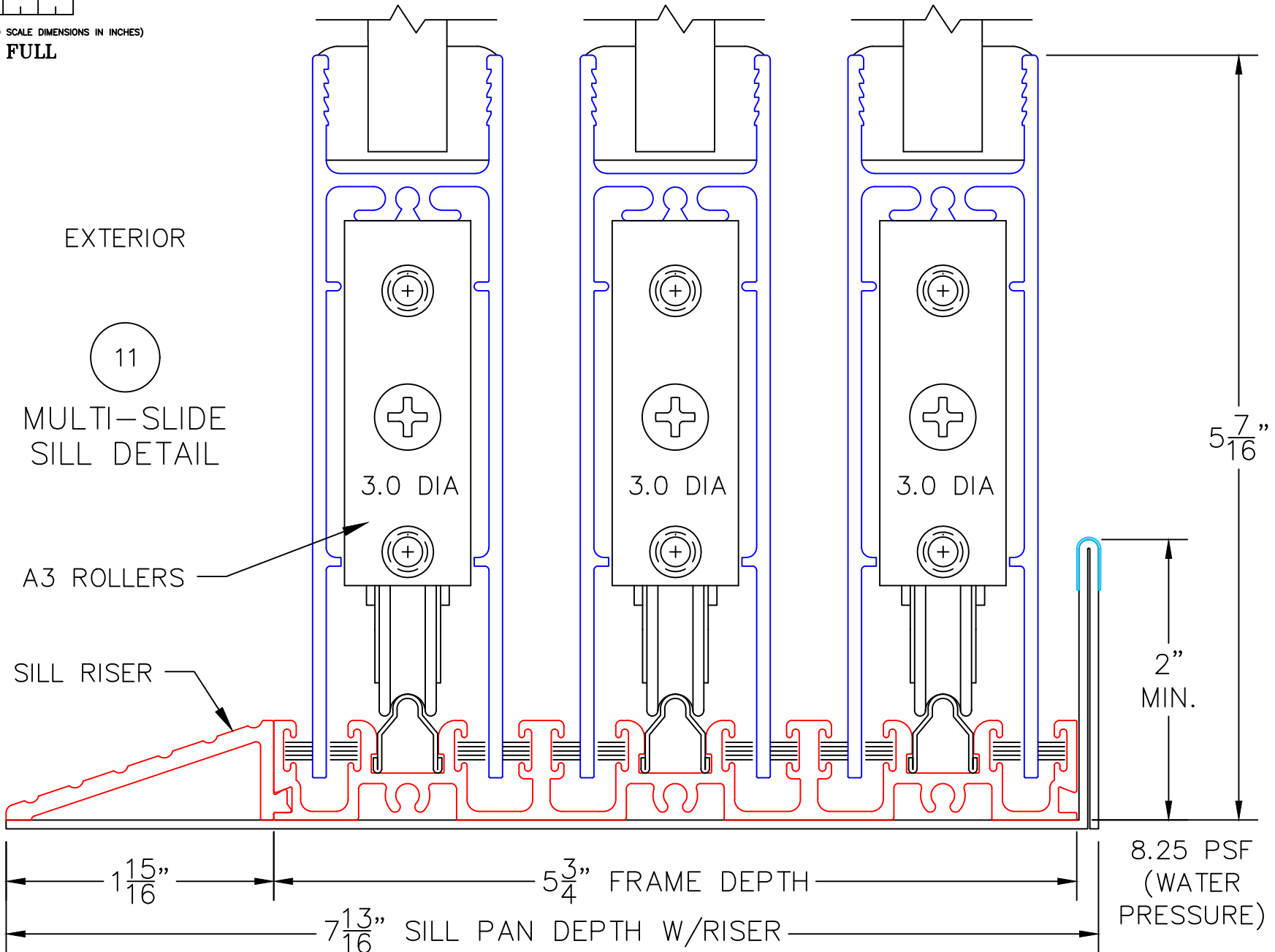

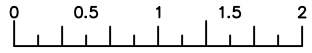

(USE RULER TO SCALE DIMENSIONS IN INCHES)

SCALE: 3/4

OXIXO DOOR

12

MEETING STILES

