

SERIES 3050

ANCHOR LOCATION WORKSHEET

BLOCK FRAME

FRAME ANCHOR CHECKLIST

FASTENER TYPE	
MINIMUM EMBEDMENT	
MINIMUM EDGE DISTANCE	
ANCHOR LOCATIONS	
FROM ENDS	
ON CENTER	

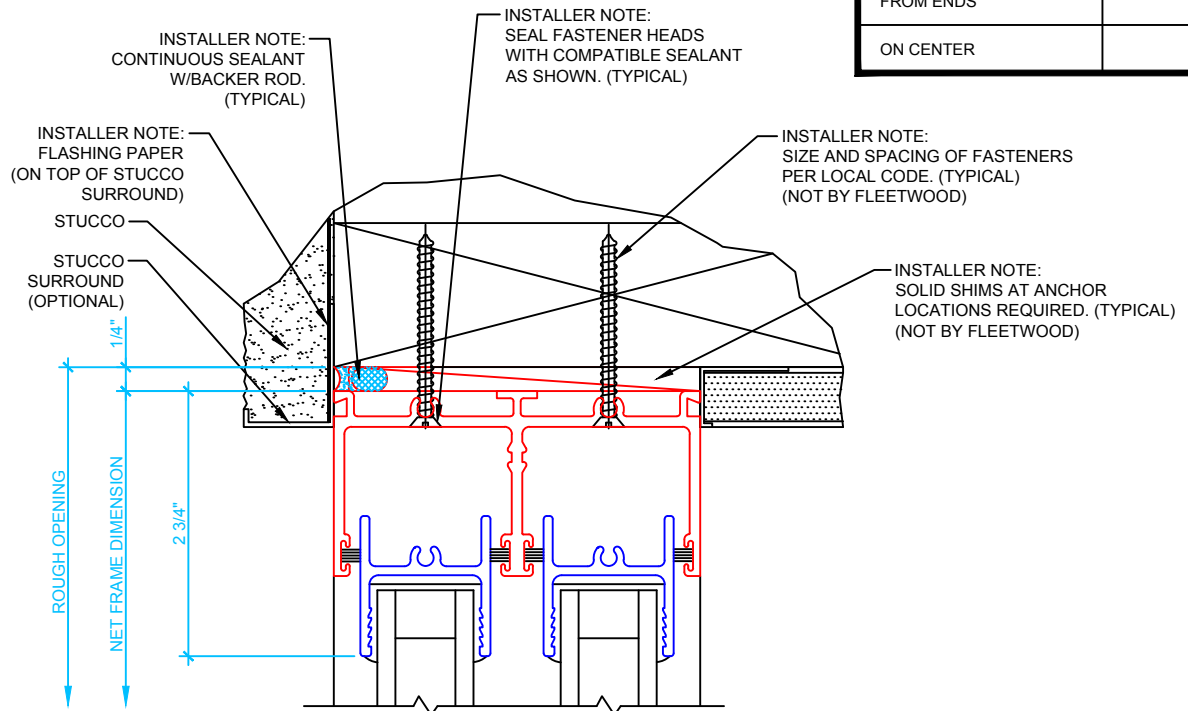

EXTERIOR

1 DOOR HEAD
SCALE: 6" = 1'

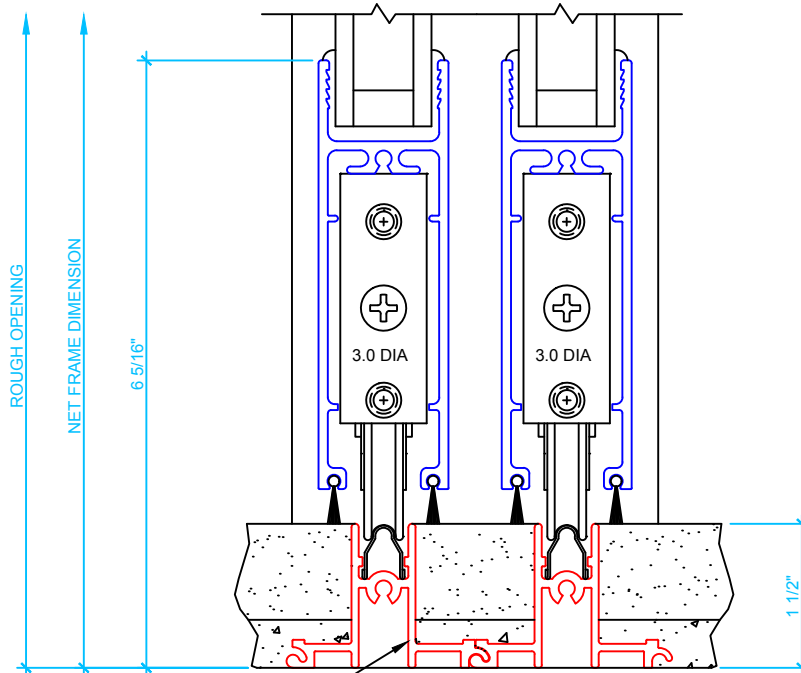

2 DOOR SILL
SCALE: 6" = 1'

SILL DISCLAIMER: IT IS THE MANUFACTURERS DESIRE FOR THE INSTALLER TO **NOT** PIERCE THE SILL. IN SOME CASES THE CODE OR SPECIFICATIONS REQUIRE SUCH. IN THESE CASES THE INSTALLER IS RESPONSIBLE TO SEAL THESE BREACHES.