

(USE RULER TO SCALE DIMENSIONS IN INCHES)
SCALE: AS NOTED

MULTI-SLIDE CURVED DOOR DETAILS
(MINIMUM 12' RADIUS)
9/16" GLAZING

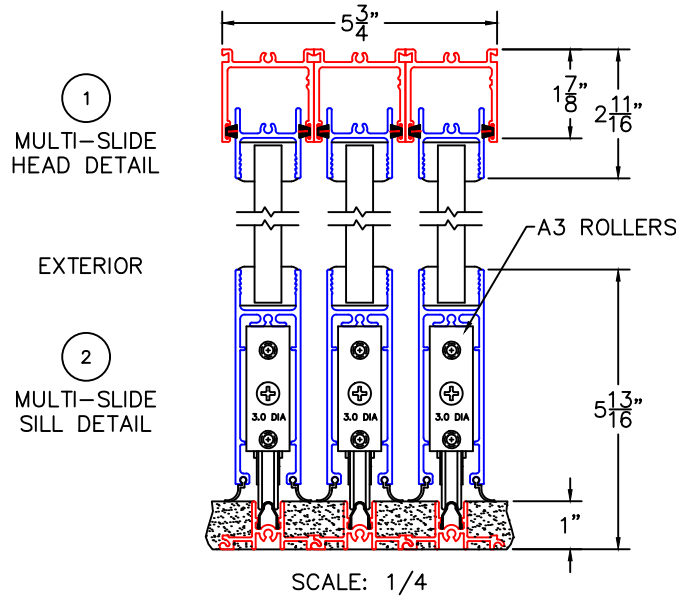

- 3 POCKET JAMB
- 4 POCKET INTERLOCKER
- 5 INTERLOCKERS
- 6 INTERLOCKERS
- 7 MEETING STILES
- 8 INTERLOCKERS
- 9 INTERLOCKERS
- 10 LOCK JAMB

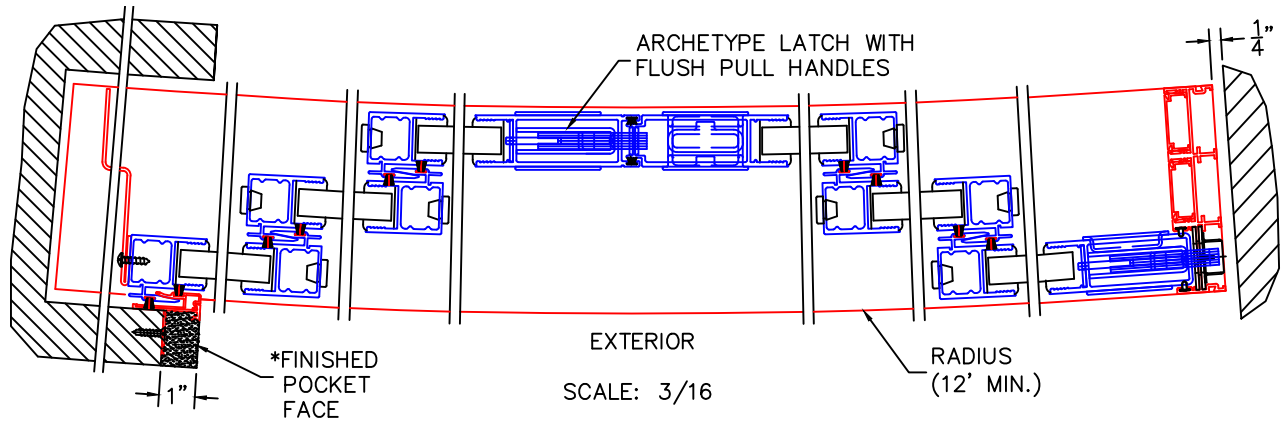

NOTE: CENTERLINES ARE NOT DIVIDED EQUALLY; CONFIRM CENTERLINES WHEN REQUIRED.

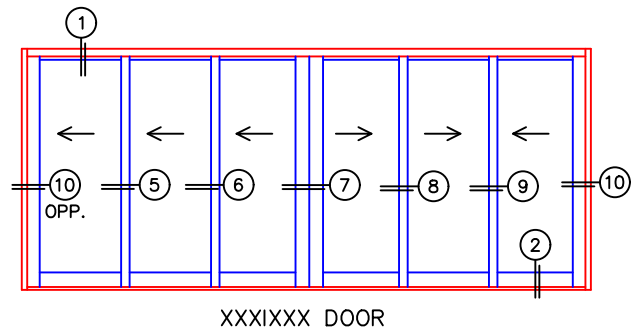
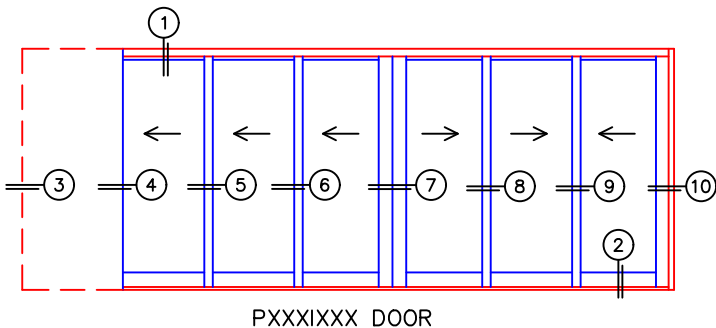

-GLASS PENETRATION: 11/16"
-FOR ADDITIONAL OPTIONS AND UPGRADES
SEE DRAWINGS 3050-08, 3050-09 & 3050-10.

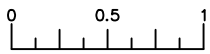

(USE RULER TO SCALE DIMENSIONS IN INCHES)

SCALE: FULL

XXX DOOR

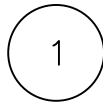

MULTI-SLIDE
HEAD DETAIL

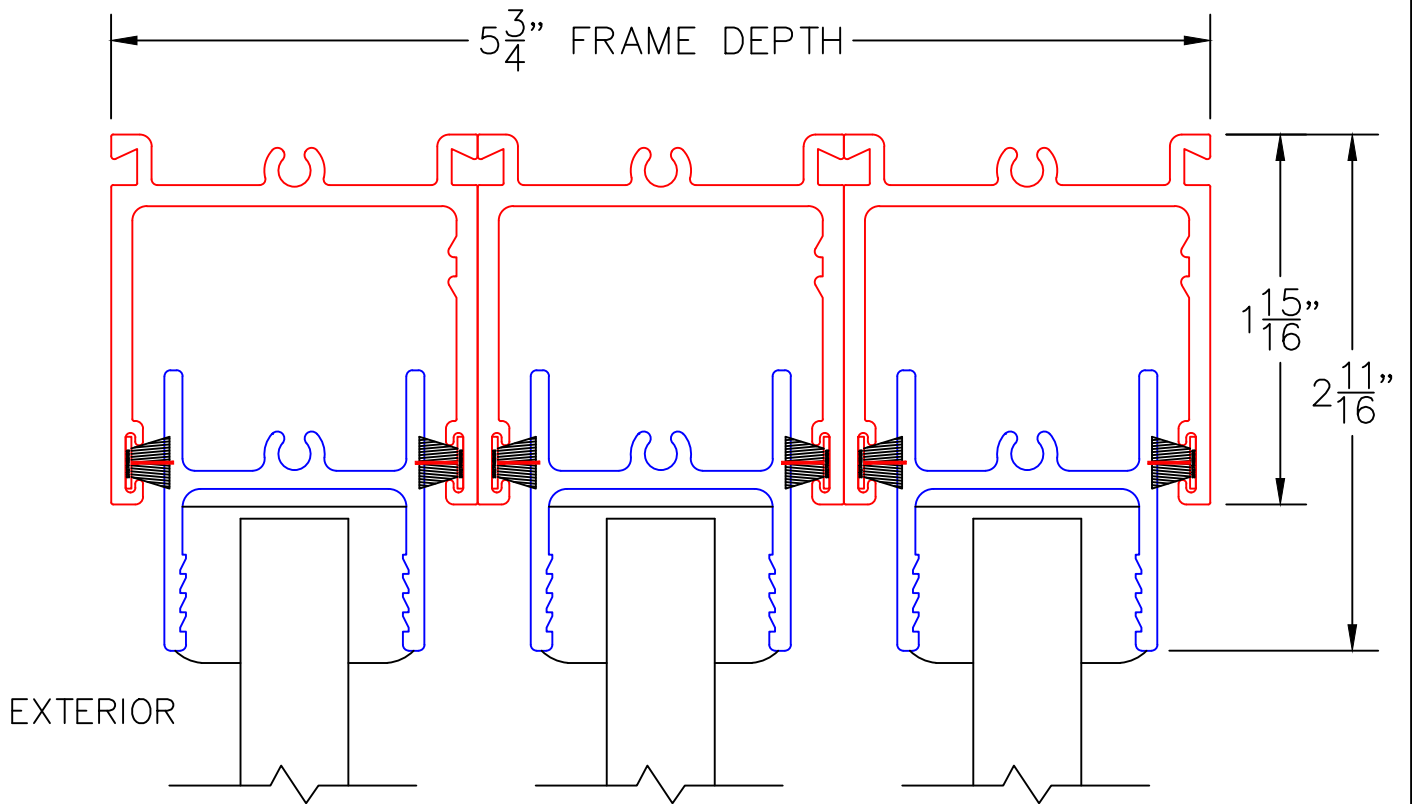



(USE RULER TO SCALE DIMENSIONS IN INCHES)

SCALE: 3/4

XXX DOOR

2

MULTI-SLIDE
SILL DETAIL

EXTERIOR

