

(USE RULER TO SCALE DIMENSIONS IN INCHES)

SCALE: 1/4

MULTI-SLIDE DOOR DETAILS
90° CORNER

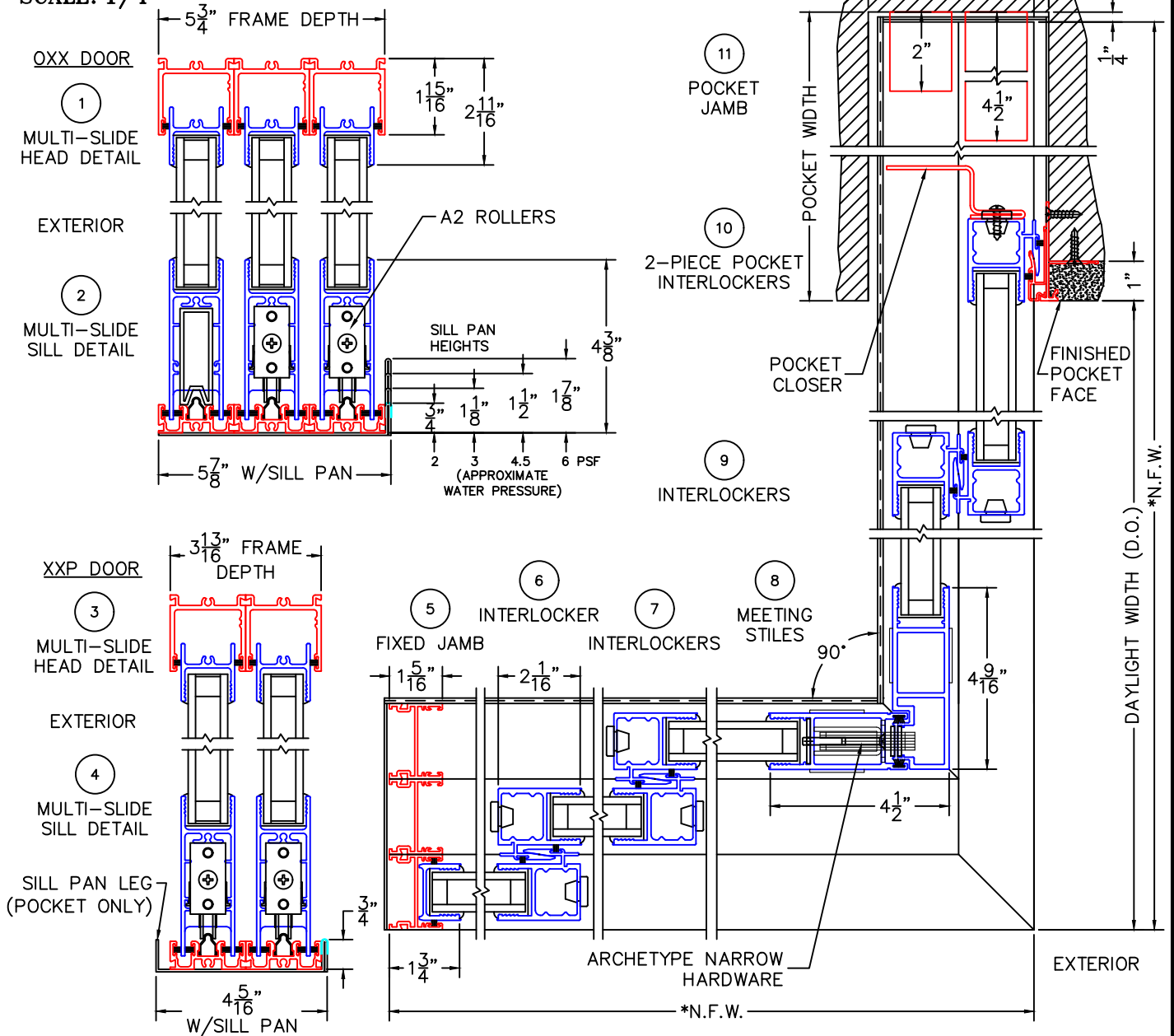

NOTE: CENTERLINES ARE NOT DIVIDED EQUALLY;
CONFIRM CENTERLINES WHEN REQUIRED.

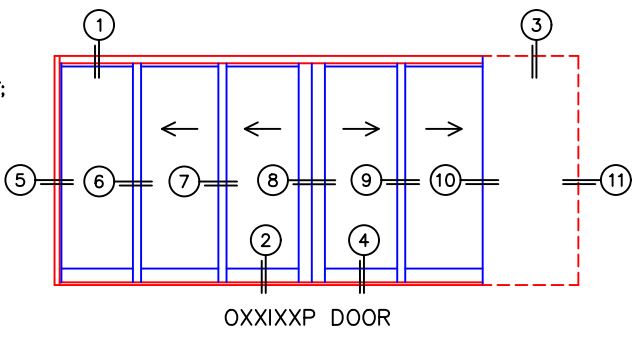

- GLASS PENETRATION: 11/16"
- *NET FRAME WIDTH DOES NOT INCLUDE SILL PAN.
- SILL PAN EXTENDS 1/8" BEYOND EACH JAMB.
- EXTERIOR RATED PRODUCTS HAVE WEEP SLOTS ON HORIZONTAL SILLS.
- FOR ADDITIONAL OPTIONS AND UPGRADES SEE DRAWING 1070-07.

NOTE: PANELS DO NOT FLUSH STACK

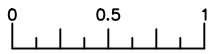

(USE RULER TO SCALE DIMENSIONS IN INCHES)

SCALE: FULL

OXX DOOR



MULTI-SLIDE
HEAD DETAIL

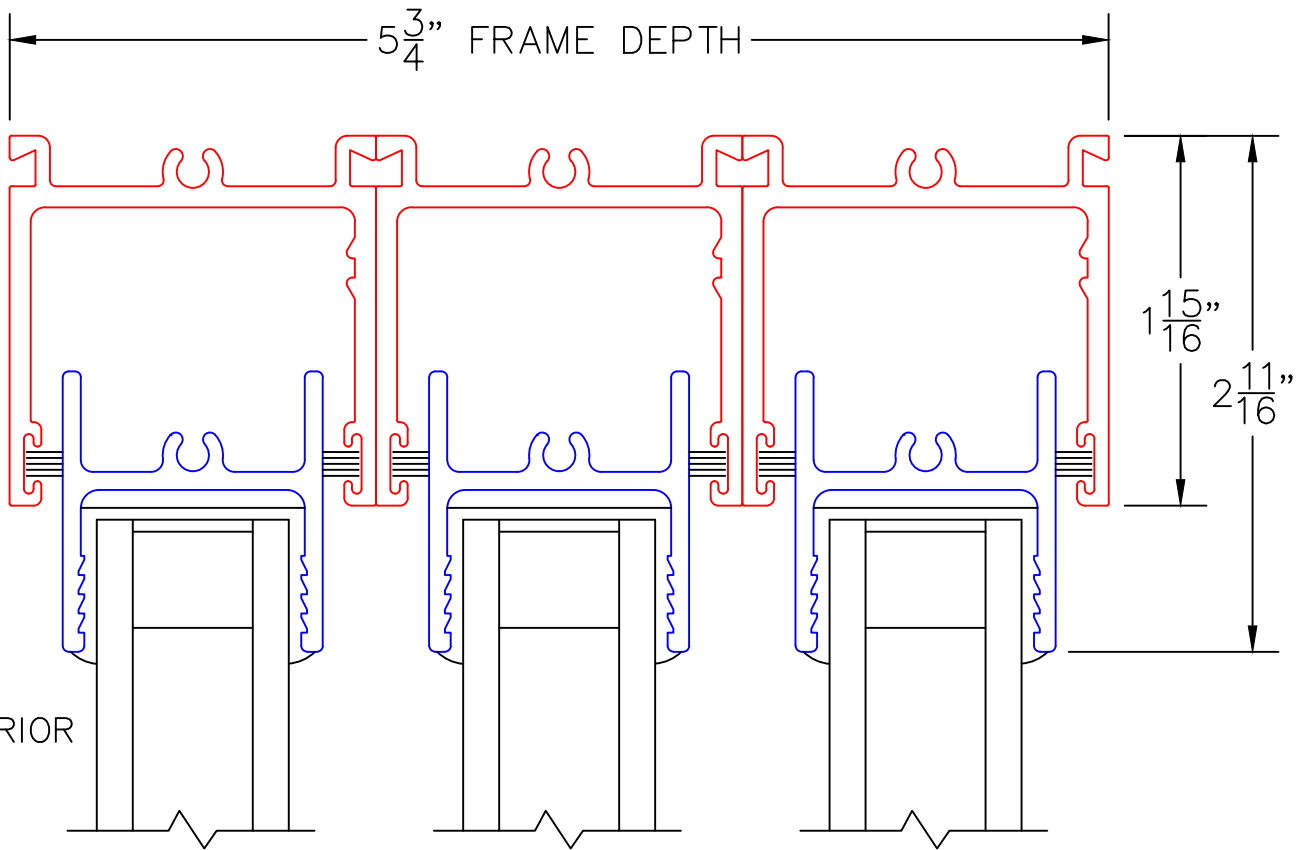

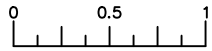

(USE RULER TO SCALE DIMENSIONS IN INCHES)

SCALE: FULL

OXX DOOR

A2 ROLLERS

EXTERIOR

2

MULTI-SLIDE
SILL DETAIL

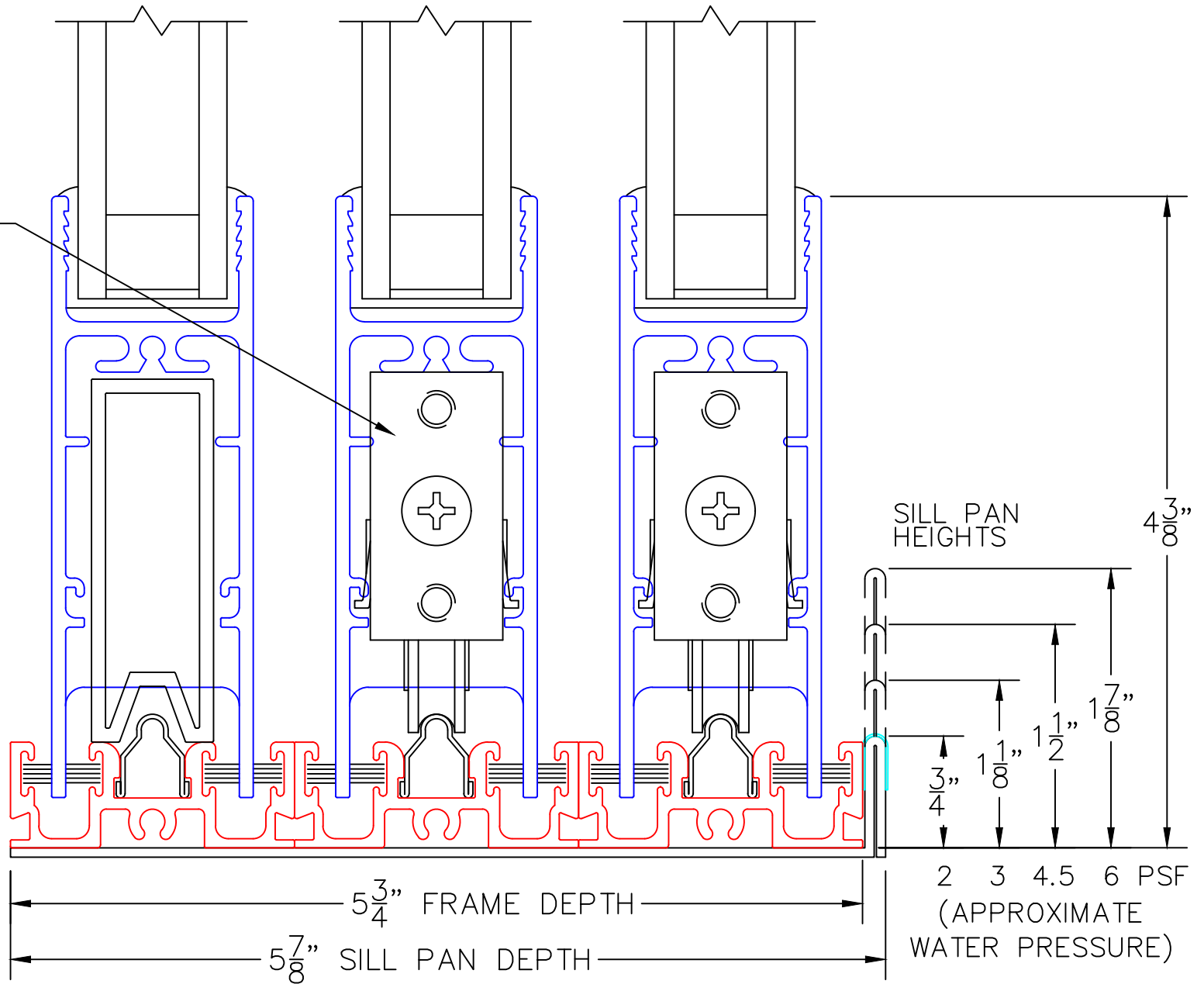

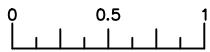

(USE RULER TO SCALE DIMENSIONS IN INCHES)

SCALE: FULL

XXP DOOR

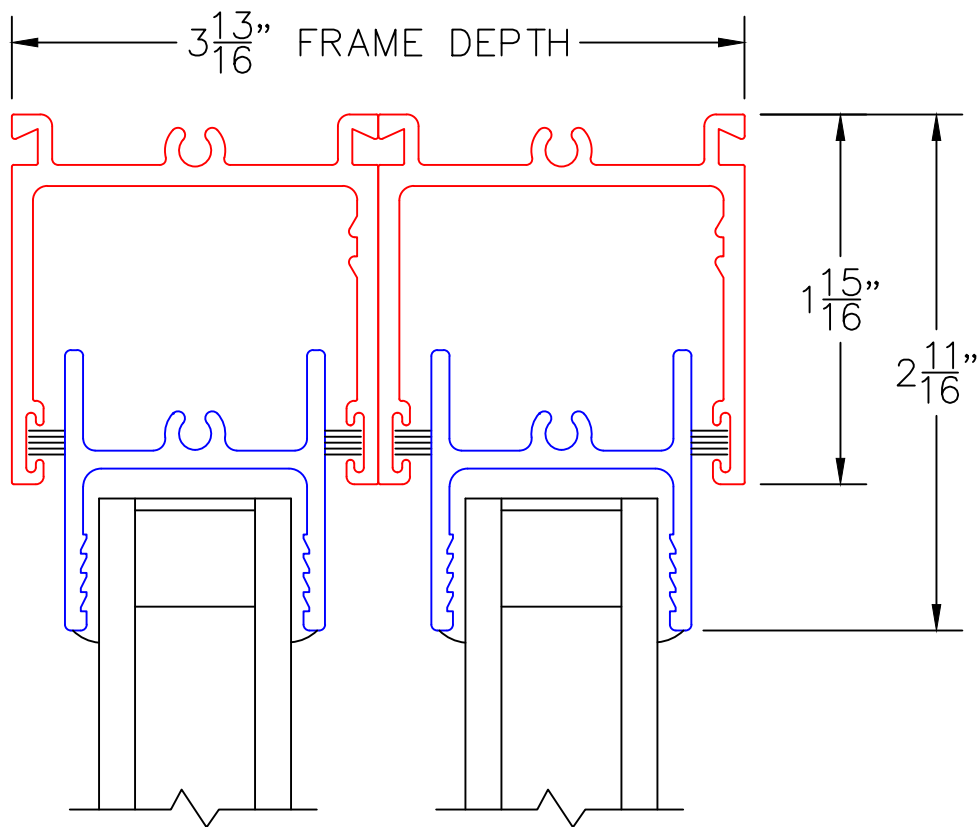

3

MULTI-SLIDE
HEAD DETAIL

EXTERIOR

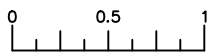

(USE RULER TO SCALE DIMENSIONS IN INCHES)

SCALE: FULL

XXP DOOR

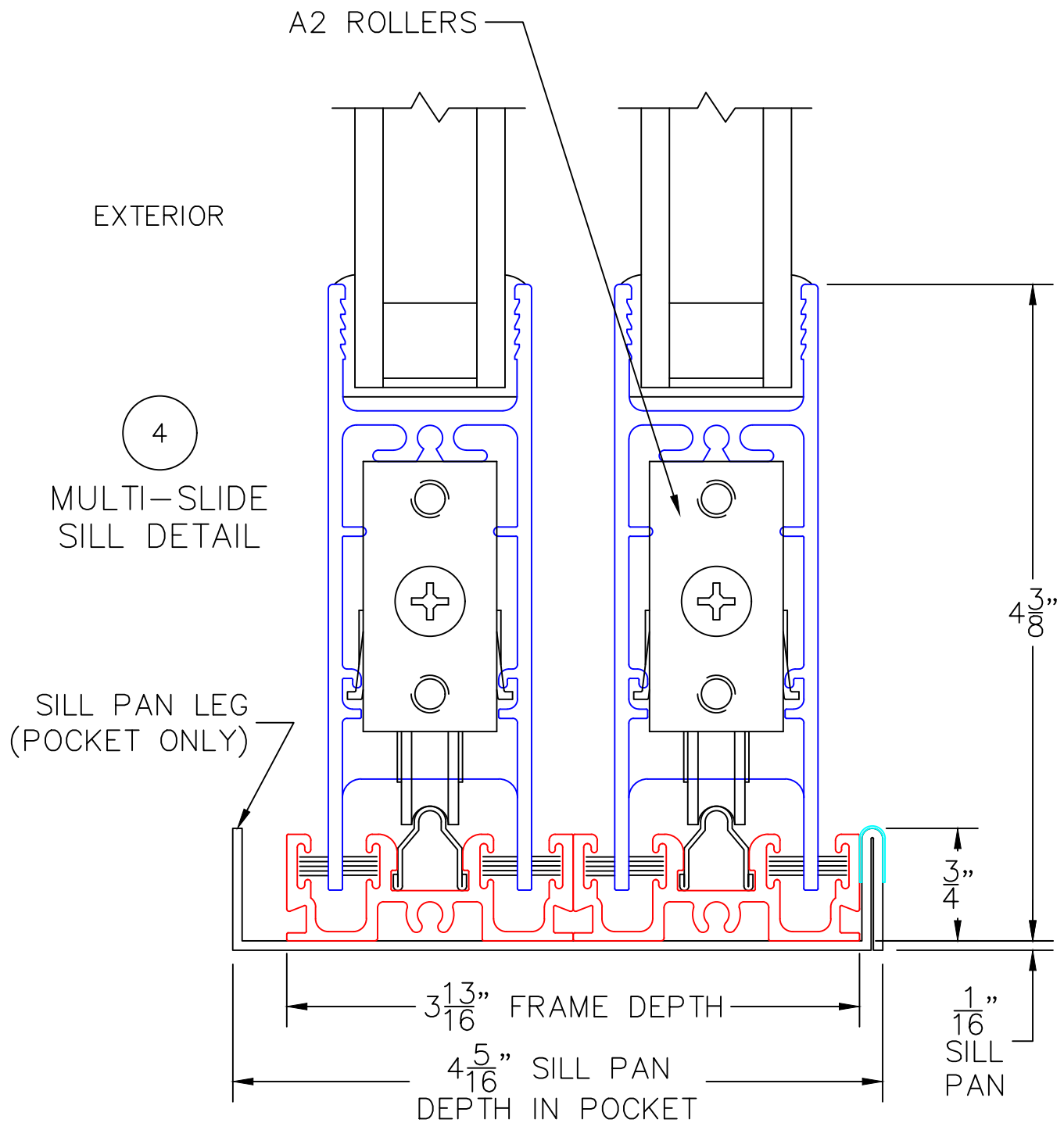

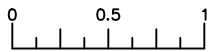

(USE RULER TO SCALE DIMENSIONS IN INCHES)

SCALE: FULL

OXX DOOR

5

FIXED JAMB

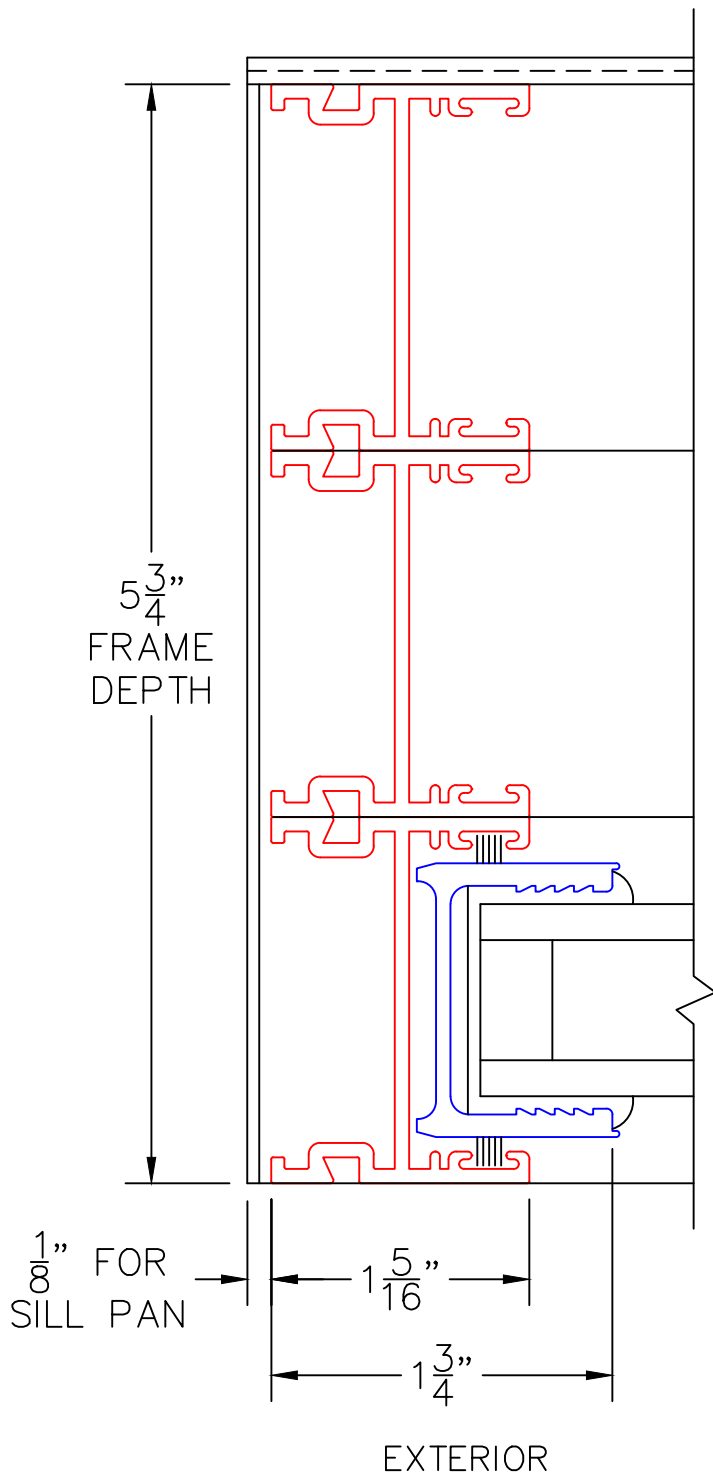

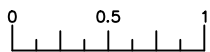

(USE RULER TO SCALE DIMENSIONS IN INCHES)

SCALE: FULL

OXX DOOR

6

INTERLOCKER

2 1/16"

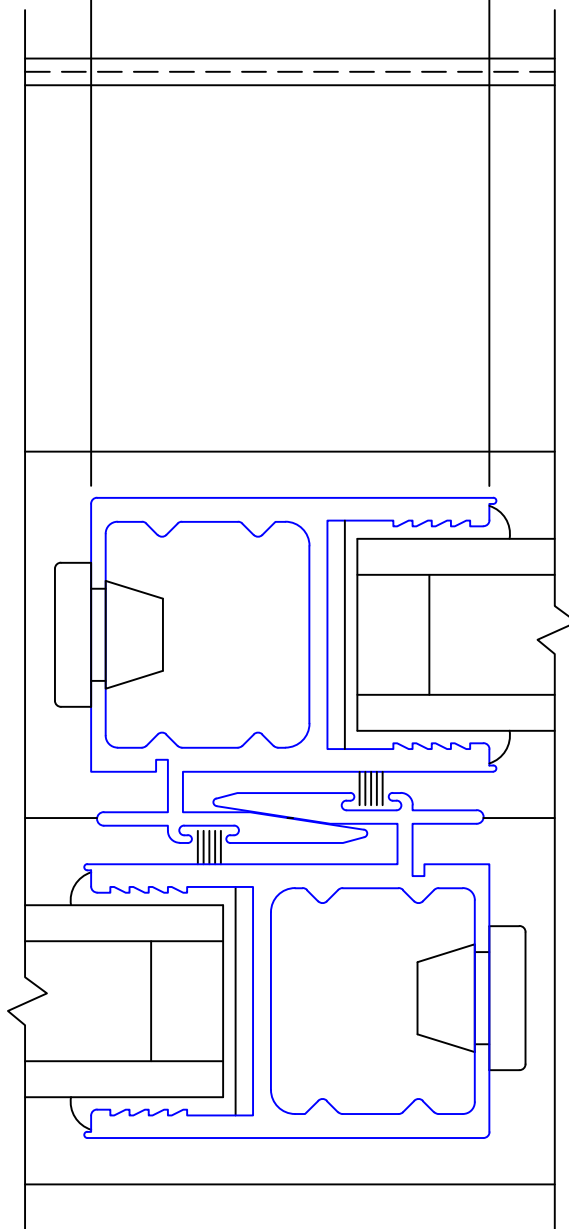

EXTERIOR

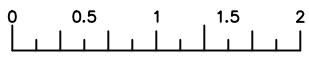

(USE RULER TO SCALE DIMENSIONS IN INCHES)

SCALE: 3/4

OXXIXXP DOOR

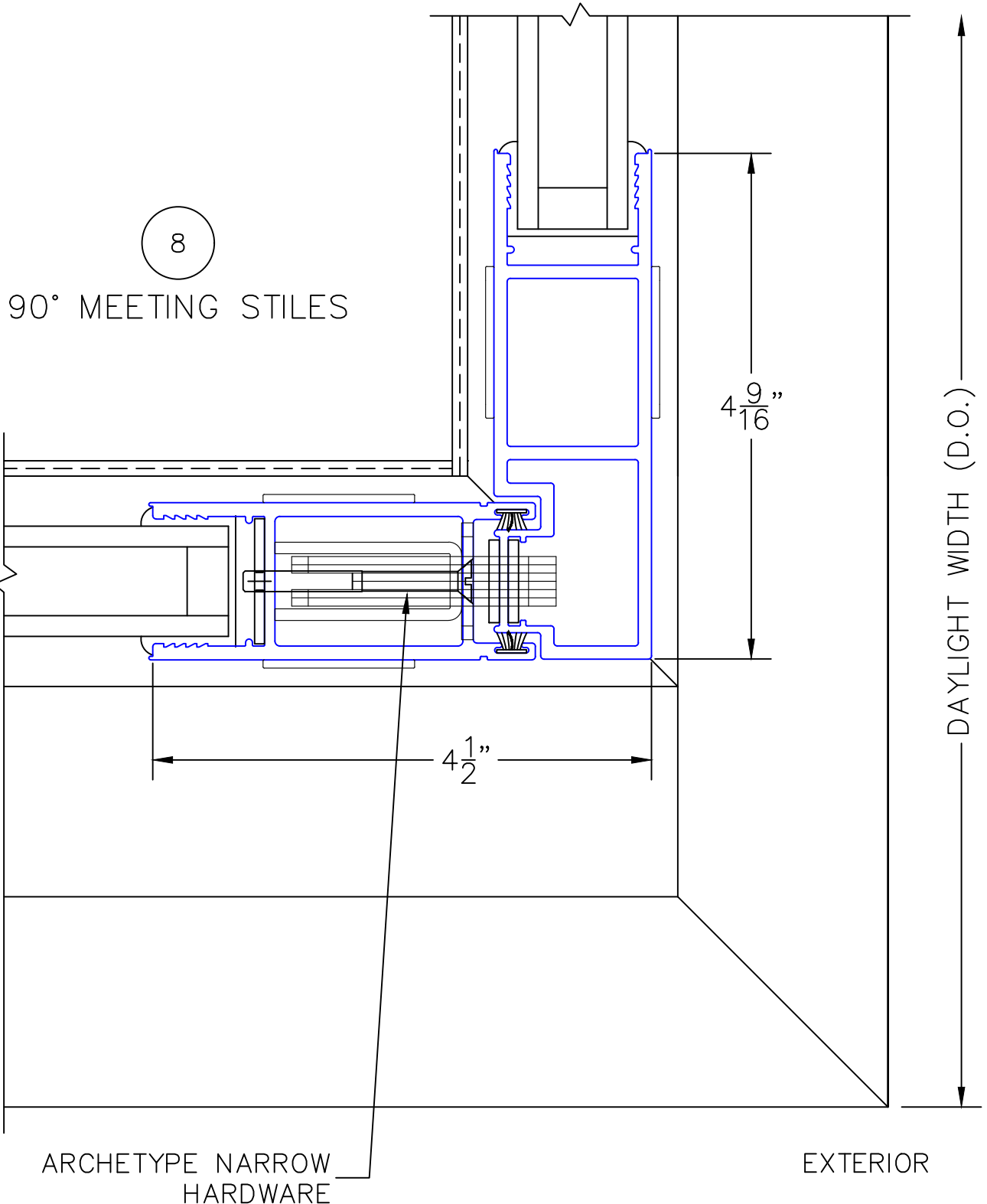

8

90° MEETING STILES

4 ⁹/₁₆''

4 ¹/₂''

ARCHETYPE NARROW
HARDWARE

EXTERIOR

DAYLIGHT WIDTH (D.O.)

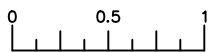

(USE RULER TO SCALE DIMENSIONS IN INCHES)

SCALE: FULL

XXP DOOR

9

INTERLOCKER

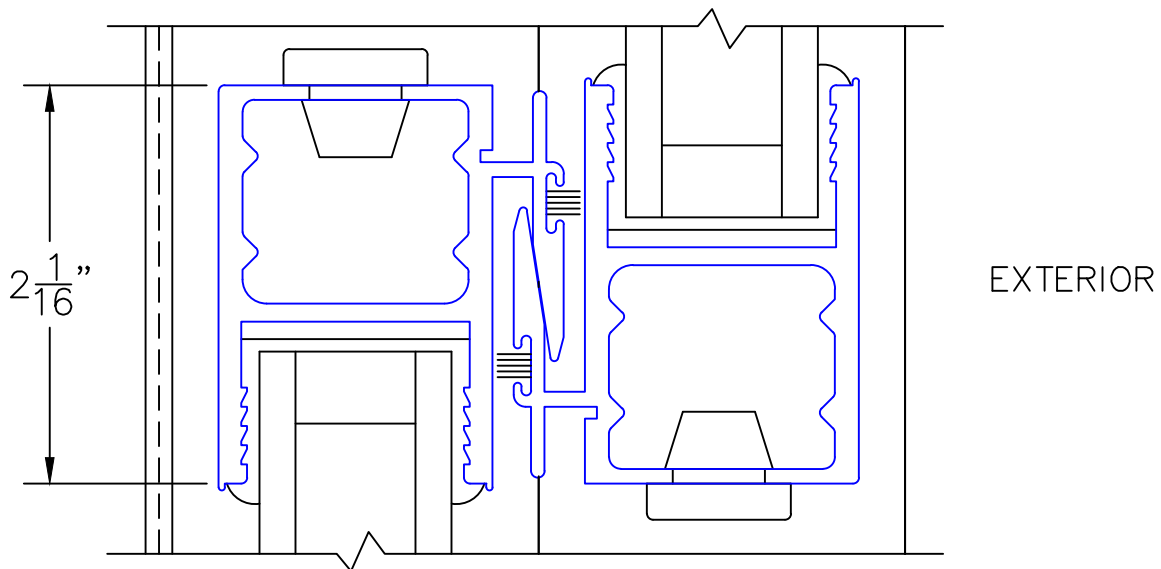

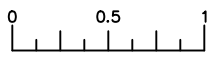

(USE RULER TO SCALE DIMENSIONS IN INCHES)

SCALE: FULL

XXP DOOR

10

TWO-PIECE POCKET INTERLOCKER

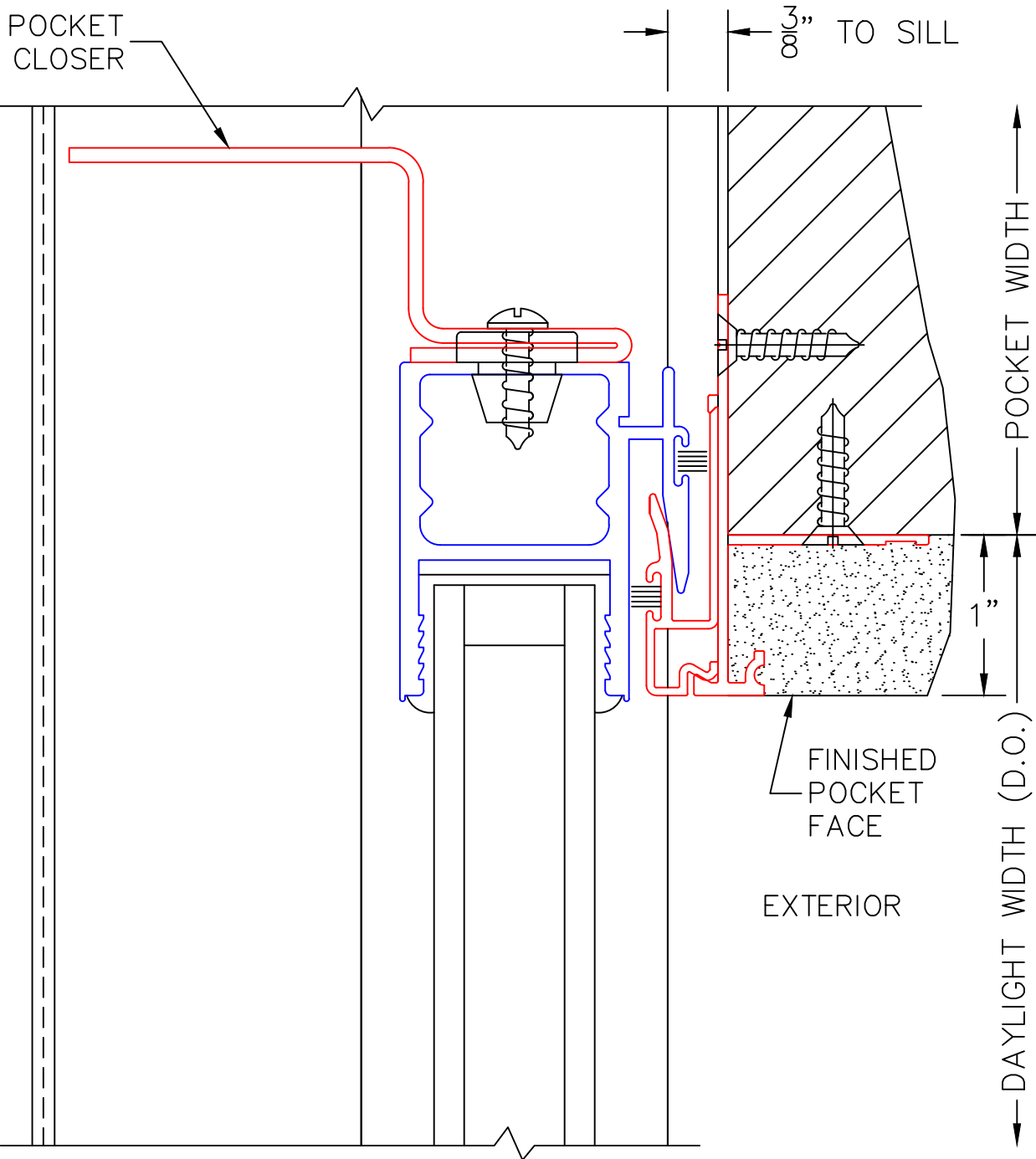

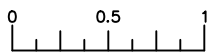

(USE RULER TO SCALE DIMENSIONS IN INCHES)

SCALE: FULL

XXP DOOR

11

POCKET
JAMB

