

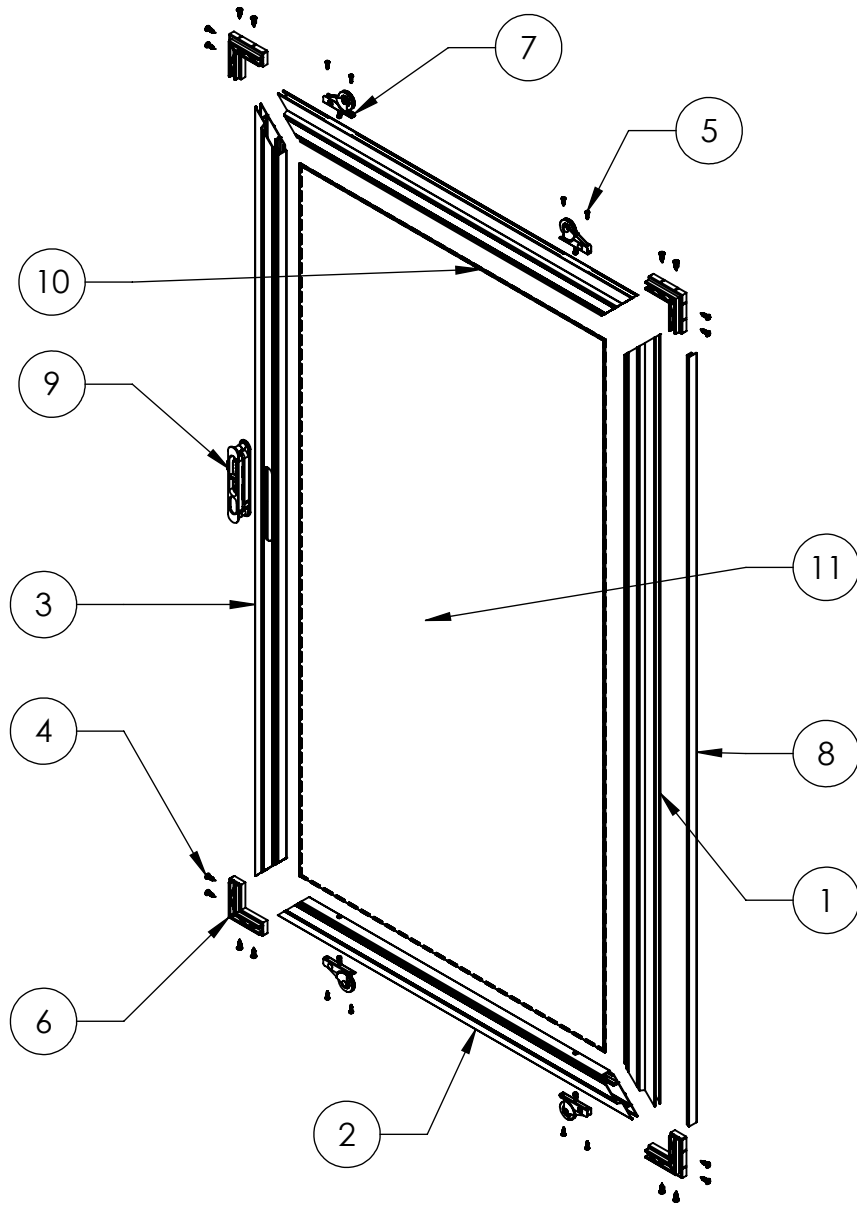

# ASSEMBLY / PARTS LIST (B.O.M.)



ITEM NO.	PART NUMBER	DESCRIPTION	QTY.
1	145	Screen Extrusion	1
2	145	Screen Extrusion	2
3	145	Screen Extrusion	1
4	-	# 10 Size, .625 Length, Pan Head Phillips Screw for Sheet Metal, Zinc-Plated Steel,	16
5	-	6-20 Thread, .5 Long, Drill Point #2, Pan Head Drilling Screw for Metal, Zinc-Plated Steel	8
6	20489	Screen Corner Door B1240	4
7	22905	Screen Roller, 1.25" dia., Stainless Steel	4
8	20531	bug wipe screen 1000, 30000	1
9	20474	Screen Handle	1
10	19130	Screen Rubber Spline .160	1
11	-	Screen Mesh	1

\*\*Note - Include 18915 screen strike kit\*\*

TITLE: SERIES 1000 ASSEMBLY SCREEN	
DWG. NO. Series_1000_Assembly_Parts List Screen	REV
DATE: 1/6/15	SHEET 1 OF 1

**PROPRIETARY AND CONFIDENTIAL**  
THE INFORMATION CONTAINED IN THIS DRAWING IS THE SOLE PROPERTY OF FLEETWOOD WINDOWS & DOORS.  
ANY REPRODUCTION IN PART OR AS A WHOLE WITHOUT THE WRITTEN PERMISSION OF FLEETWOOD WINDOWS & DOORS IS PROHIBITED.